

drive

 DeVilbiss[®]
HEALTHCARE

Casa Elite & Casa Elite Low
Community Care Bed

Instructions for use



This document is to be used in conjunction with the full instructions for use document. Read all warnings prior to using this guide. This Quick Reference Guide does not replace the full instructions for use.



1. Assembly/Disassembly

- 

1 Apply Brakes
- 

2 Locate Allen Key
- 

3 Remove all R-Clips from Clevis Pins
- 

4 Remove backrest section from Transport Stand with Allen Key.
- 

5 Rotate backrest actuator through 180°
- 

6 Remove leg section from Transport Stand.
- 

7 Separate Bed Ends from Transport Stand (unscrew bolts under Transport Stand).
- 

8 Lower platform section onto bed end laid flat on the floor.
- 

9 Ensure section ends are fully pushed up against bed end corner posts. Secure fixings.
- 

10 Fit platform sections to the bed ends, ensuring individual sections are secured before moving.
- 

11 Ensure screws at bed ends and in the centre of the platform are fully tightened.
- 

12 Replace all Clevis Pins
- 

13 Fit clevis pins from bed kit to platform centre
- 

14 Check ends are still fully pushed up against platform.
- 

15 Fit Finger Kits to channels.
- 

16 Fit Wooden/Metal Side Rails to Finger Kits.
- 

17 Fully raise Side Rails.
- 

18 Check ends are still fully pushed up against platform.

2. Operation

- A - Backrest Position (Up/Down).
- B - Kneebreak section Position (Up/Down).
- C - Auto Contour (backrest and kneebreak together).
- D - Raise/Lower Bed.

- E - Foot Down Tilt.
- F - Head Down Tilt
- *(Available with 10 button handset accessory only).
- G - Standard Leg Stay Function (Angle).

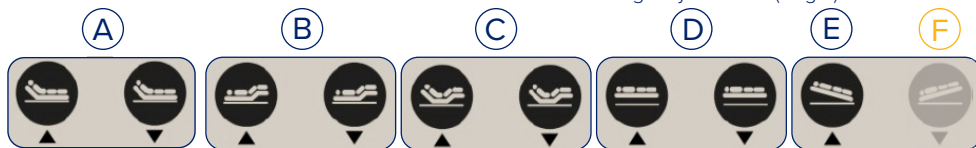

The Casa Elite range of beds are intended to be used with patients up to 165kg and of height in the range of 146-201cm. It is not intended to be used with patients of less than 40kg. The Casa Elite requires a power supply of 100-240V at 50/60Hz, with no more than 2A. The Casa Elite Low has a minimum and maximum mattress platform height 19.2cm lower than the standard height bed, but is operated the same way and thus these instructions still apply. Ensure labels on the bed are checked when routing cables from actuators to the control box to ensure functionality of the bed is as intended.

Information for Regular Use:

Brake System:

The bed has four braked castors.

- To apply the brakes - Press the brake pedal down.
- To release the brakes - Lift the brake pedal up.

Side Rails:

When lowering the safety side rails, they must first be lifted to release the catch to allow them to slide down the channels. Always lower them gently to the bottom stop.

To raise the rails, lift the rail until it clicks into place. Refer to your safe side rail policy when using safety sides.

Leg Stay Function (G):

The calf section of the bed can be raised to enable the users calf to remain elevated. Once the knee break has been set at the desired angle, the leg stay angle can be set by lifting and releasing this section manually on the ratchet (if accessory is present).

To release, raise the leg section to the highest height and then lower

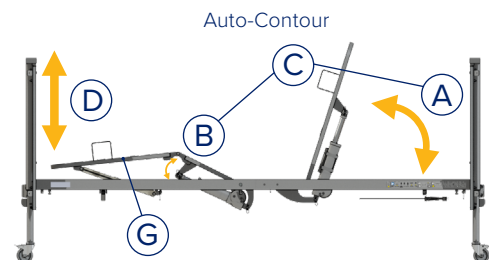

The handset is supplied with a lockout function which disables bed functions if they are deemed unsuitable for the occupant.

To lock/unlock a function, turn the handset over and insert the handset key provided into the recess. Turn to the required position (anticlockwise to lock, clockwise to unlock). As the key is rotated the light will illuminate green to show the handset is unlocked.

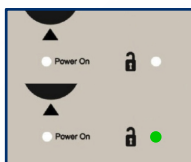

Handset unlocked



*Head down tilt function locked.

Handset fully locked

Handset Locking

The bed must not be used/moved if any fixings are missing or loose.

All moving parts are to be secured prior to moving the bed in transport stand.

All cables must be loose and free of moving parts of the bed.

All warning in the full instructions for use should be read and understood prior to using the bed.

A 9 button handset is provided as standard, if a 10 button handset is required, please see Section 18.

Need Assistance? Call 01422 233 136 (8:30am - 5pm) or 0800 037 0234 (out of office hours)

Drive DeVilbiss Healthcare Ltd. | Casa Elite

Quick Reference Guide | rev5

CONTENTS

1. INTRODUCTION	5
2. CONTACT INFORMATION	5
3. PRODUCT DESCRIPTION	6
3.1 Environment	6
3.2 Intended Patient Group.....	6
3.3 Intended Use.....	6
3.4 Indications	6
3.5 Product Overview	6
3.6 Features	7
4. SAFETY	8
4.1 Warnings and Cautions	8
4.2 Risk Assessment	8
4.3 Contraindications	8
4.4 Bed Load	9
4.5 Training	9
4.6 General Warnings	10
5. TRANSPORT AND STORAGE	11*
6. SYMBOL DEFINITION	12
7. PARTS IDENTIFICATION	14
8. BED ASSEMBLY AND PREPARING FOR USE	15*
8.1 Removal from the Transport Stand	15*
8.2 Assembling the Bed	16*
8.3 Fitting the Electrical System	17*
8.4 Cable Routing	18*
8.5 Ancillary Product Cable Routing	18*
8.6 Fitting the Side Rails	19*
8.7 Side Rails and Mattresses	21*
8.8 Side Rail Safety	21*
8.9 Checking the Bed	22*
8.10 Fitting Ratchet	22*
8.11 Knee Break/Leg Section	23*
8.12 Lockout Function	24*
8.13 Installation/Preparing for Use	25*
9. OPERATION OF THE BED	28
9.1 Operational Limits	28
9.2 Brake System	28
9.3 Operating the Side Rails (when fitted)	29
9.4 Electrical Operation	29
10. ASSEMBLY ONTO THE TRANSPORT STANDS	31*
11. POWER FAILURES	33
12. BATTERY CHARACTERISTICS	34
13. DECONTAMINATION	34*
13.1 Cleaning and Disinfection Guidelines	34*
13.2 Steam Cleaning	35*
14. MAINTENANCE	36*
14.1 General Inspection	36*
14.2 Fault Finding	36*
14.3 Servicing	37*
15. DISPOSAL OF PARTS	38*
16. SPECIFICATION	39
16.1 Bed Data	39
16.2 Electrical Data	40
17. ELECTROMAGNETIC COMPATIBILITY (EMC)	41
18. ACCESSORIES	42
18.1 Mattress/Side Rail Compatibility Chart	45
19. WARRANTY	48
20. SERVICE LIFE	49
21. NOTES	50



Warning

* Highlighted pages are for authorised personnel reference only, if in doubt contact Drive DeVilbiss Healthcare Ltd. or your local distributor.

1. INTRODUCTION

Thank you for purchasing this product. These instructions for use should be read carefully before operating the bed. Please ensure that you understand all instructions, if you have any questions concerning the operation or maintenance of the bed please contact your provider/supplier who will provide you with expert professional advice. Drive DeVilbiss Healthcare Ltd. recommend the bed is assembled and maintained by Drive DeVilbiss Healthcare Ltd. service engineers or qualified personnel.

2. CONTACT INFORMATION

For assistance in setting up, using, maintaining your bed, to report unexpected operation or for any service, warranty, sales or customer service information regarding this product please contact your provider or if in doubt contact Drive DeVilbiss Healthcare Ltd. at the following address:

Drive DeVilbiss Healthcare Ltd.
Sidhil Business Park,
Holmfield,
Halifax,
West Yorkshire
HX2 9TN
Great Britain

Service & Maintenance

Tel: +44 (0)1422 233136

Fax: +44 (0)1422 233010

Spares

Tel: +44 (0)1422 233138

Fax: +44 (0)1422 233010

Sales

Tel: +44 (0)8450600 333

Fax: +44(0)8450600 334

info@drivedevilbiss.co.uk

www.drivedevilbiss.co.uk

Any serious incident that occurs in relation to the device should be reported to Drive DeVilbiss Healthcare Ltd and the competent authority of the Member State in which the device is used. Please quote the product SN number on all correspondence. This can be found on the identification labels, which are located on the outside of the backrest section frame, on the outside of the leg section frame, and on the lower section of each bed end.

For Service & Support outside Great Britain & Northern Ireland please contact the local distribution company from where this equipment was purchased. Failure to do so may result in the manufacturer's warranty becoming void.

3. PRODUCT DESCRIPTION

3.1 Environment

Your bed is intended for use in the following environments:

- A domestic area where the bed is used to alleviate or compensate for an injury, disability or disease.
- A long term care area where medical supervision is required and monitoring is provided if necessary (e.g. nursing homes, rehabilitation facilities, geriatric facilities etc.).

3.2 Intended Patient Group

The bed frame is intended for an adult who is up to 165kg in weight. A lower (or upper) age limit is not defined as it depends on the physical size of the patient in relation to the various proportions and gaps around the bed frame. Patients must be in excess of 146cm in height ranging up to 201cm (bed extended) and have a BMI greater than 17.

The bed frame is intended to support a single adult.

3.3 Intended Use

The intended use of the bed is to support the weight of the patient as defined in section 3.2, whilst sleeping or resting and to assist the end user to gain and/or maintain a suitable position.

3.4 Indications

To assist in the care and/or comfort of the patient or care provider when the bed is used in the environments intended in section 3.1.

3.5 Product Overview

The Casa Elite bed is intended to be plugged into a permanent mains supply. A battery backup accessory is available for such times that a mains supply is not available or reliable. A low height version of the bed is also available, the low height bed has a minimum and maximum mattress platform height 192mm lower than the standard height bed.

The bed has one handset, intended for use by both the patient and carer, which provides the carer with the ability to lock out the use of bed functions as necessary to reduce the risk of accidental operation. It is the carer's responsibility to determine that the patient is both mentally and physically capable of operating the handset with minimal risk of personal injury.

The handset operates an electronic linear actuator system, which is controlled via a central control box. The actuators are attached to the moving parts of the bed frame allowing the bed to be operated via the use of the handset.

Two powder coated steel bed ends support the mattress platform frame, the electrical system and a set of side rails (when fitted) to provide patient protection; the bed has a safe working load of 200kg. The bed is manoeuvrable via the aid of four individually braked castors which are attached to the bed ends, however it is not designed for patient transportation. The bed can be disassembled into four separate sections, which can be assembled onto the transport stands provided with the bed, aiding transportation and storage.

3.6 Features

- Electrically operated backrest, height adjustment and leg rest angle.
- Electrically operated foot down tilt.
- Auto contour – simultaneous adjustment of the backrest and leg rest sections.
- Battery backup functionality (with CASA/BATTERY/1 only).
- Patient handset with lockout.
- Optional integral full length side rails.
- Can be broken down into four separate sections.
- Transport stands to aid storage and bed transportation.



Warning

- The 9 button handset provided omits the head down tilt function for safety reasons. If a head down tilt function is required a replacement handset can be purchased featuring this function. Please refer to section 18 for the part code, and refer to the contact information in section 2 to order or to request further information – Drive DeVilbiss Healthcare Ltd. recommend the use of the standard 9 button handset when the bed is being used in a domestic environment.
- The Casa Elite Low does not meet the upper height and under bed requirements of EN 60601-2-52, if patient or carer requirements are such that the height range is deemed to pose a potential hazard the Casa Elite should be used instead, please refer to the contact information in section 2 to request further information.

4. SAFETY

4.1 Warnings and Cautions



Warning

Warnings in these instructions for use highlight potential hazards that if disregarded could lead to injury or death.



Caution

Cautions in these instructions for use highlight potential hazards that if disregarded could lead to equipment damage or failure.

4.2 Risk Assessment

Before a patient uses the bed a risk assessment must be performed on a patient by patient basis. The risk assessment should include, but is not limited to:

- Entrapment.
- Falling out of the bed.
- Small adults (and children).
- Patients who lack capacity.
- Unauthorised people with access to the bed.
- Use of side rails and other accessories.

4.3 Contraindications

Patient conditions for which the use of the Casa Elite and Casa Elite Low bed is a contraindication are as follows:

- Cervical or skeletal traction.
- Unstable spinal fractures - If bed functions remain unlocked.
- General skeletal fractures - If relevant bed functions remain unlocked.
- Mental capacity not sufficient to operate handset functions safely - If bed functions remain unlocked.
- Confused, agitated or restless - If side rails fitted and/or in raised position.
- Exceeds maximum patient weight of bed.
- Less than 146cm in length.
- BMI less than 17.
- Less than 40kg in weight

Other contraindications may be relevant which are specific to the patient or care environment.

4.4 Bed Load

Safe working load: **200kg (31½ stone)**

Maximum patient weight: **165kg (26 stone)**

Safe working load is the sum of:

- Patient mass.
- Mattress mass.
- Accessories mass.
- Mass supported by the accessories (excluding patient mass).



Warning

The maximum loads shown above are for the bed to be occupied by one person only. The bed is not designed to take the weight of visitors sitting on the side of the bed. Additional weight could damage components or cause the bed to become unstable, potentially causing injury.

4.5 Training

All professional users are to be suitably familiar with the bed's functionality and its limitations prior to use. Patients are to be familiarised with handset and bed functionality by the professional user at the earliest opportunity, ideally before using the product.

It is the responsibility of the professional user to ensure they are suitably qualified to use the bed and any associated accessories safely and correctly. If these instructions for use are not deemed sufficient and the need for training is required please contact Drive DeVilbiss Healthcare Ltd. or your local provider (see section 2) who will be able to discuss training options with you.

4.6 General Warnings



Warning

- The bed is to be installed and put in to service in accordance with the information provided in these instructions for use.
- The bed is typically not suitable for child use, if it is to be used for child occupancy ensure a risk assessment has been undertaken taking in to account the proportions of the child and dimensions of the bed frame.
- The bed is not suitable for occupants who are less than 146cm in length - If in doubt please contact your provider or Drive DeVilbiss Healthcare Ltd. for further advice.
- The bed is not suitable for occupants who weigh less than 40kg - If in doubt please contact your provider or Drive DeVilbiss Healthcare Ltd. for further advice.
- The bed is not suitable for occupants who have a BMI less than 17 - If in doubt please contact your provider or Drive DeVilbiss Healthcare Ltd. for further advice.
- Misused electrical equipment can be hazardous.
- Accessories that have not been approved or designed for use with the bed are not be used - a hazard could be introduced due to product combination incompatibility.
- Modification of the bed frame is not allowed without the permission of Drive DeVilbiss Healthcare Ltd. – a hazard could be introduced.
- Electrically operated beds should not be used in the presence of flammable gasses or used in oxygen rich environments - risk of explosion/fire.
- Keep the bed away from sources of heat and naked flames (e.g. cigarettes, electric fires, fan heaters etc.) - risk of explosion/fire.
- Bed functions must be locked out if there is any doubt about the ability of the patient to operate the bed safely.
- If children, adults who lack capacity or even pets pose a potential risk of intentional or unintentional tampering with the bed its suitability for use is to be considered during the initial patient/product risk assessment.

5. TRANSPORT AND STORAGE

The following conditions should be followed when transporting and storing the bed:

- To save space, the bed should be stored on the transport stand.
- Ensure all fixings are in place and secured when transporting.
- The bed should always be stored on a flat and level floor.
- The bed ends should be set to minimum height.
- Side rail components, if applicable, (not including side rails) to be kept in the channels on the bed ends (or stored safely together).
- The brakes should be applied.
- All profiling sections should be secured with supplied cable ties (or similar).
- All functions on the handset should be locked out.
- The bed should be covered to protect it from fluid ingress, dirt, dust etc.
- Beds should not be stored one on top of another or on their side.

	Operational Limits	Transport/Storage Limits
Ambient Temperature	+10°C to +40°C	-20°C to +50°C
Humidity	30% - 75%	30% - 75%
Atmospheric Pressure	800 to 1060hPa	800 to 1060hPa
Altitude	≤ 2000m	≤ 2000m



Warning

- The bed is not intended for patient transport, it is not to be moved out of the room it is located in with a patient occupying the bed - risk of patient/carer injury. If the bed is to be moved within the room with an occupant in the bed a risk assessment in line with local health and safety policy is to be undertaken in order to ensure that neither staff or patients are put at risk when moving the bed; this is dependent on the situation and load on the bed.
- If transporting the bed whilst on its transport stand ensure a risk assessment in line with local health and safety policy is undertaken to ensure that the staff are not put at risk when moving the bed, especially in regards to moving up/down inclines and uneven surfaces.
- The bed must never be moved on the transport stand with the grub screws missing or sections not secured - risk of bed collapse.
- To prevent the risk of cross infection, when removing a bed from an end user's residence ensure that all activities in relation to the bed are carried out using disposable gloves and that they are then discarded appropriately, unless it can be verified that the bed and any associated accessories have been suitably cleaned and disinfected prior to collection.
- On the return of a bed from an end users residence, prior to putting the bed into storage ensure it has been cleaned and disinfected in line with the local infection control policy and/or as defined in section 13 of these instructions for use.



Caution

- The bed is not to be pushed over thresholds - if done so damage to the frame could occur.
- Cable ties (or similar) used for storage should be removed after assembly and before operation - damage to the frame could occur due to restriction.

6. SYMBOL DEFINITION

The following symbols are found on this bed:



Warning
Beware of potential hazard



Caution
Beware of potential product damage



Refer to instructions for use - Recommended
Failure to read the instructions for use could introduce a hazard



Refer to instructions for use - Mandatory
Failure to read the instructions for use could introduce a hazard



Total bed weight
Including safe working load



Care is to be taken when pushing the bed over thresholds when on transport stands - Risk of tipping



Maximum patient weight
Refer to section 4.4



Safe working load
Refer to section 4.4

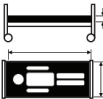

Mattress suitability
Refer to section 18



Mattress strapping suitability



Detachable side rail suitability
Use of an incorrectly specified or positioned side rail could introduce a hazard.



EC Rep



Importer



Minimum patient weight



Minimum patient BMI



Minimum patient height



Atmospheric pressure limit



Humidity limit



Temperature limit



Serial Number



Country of manufacture



Manufacturer



Catalogue number



Medical device



Class II electrical device

The user/occupant is protected by at least two layers of insulation between the current carrying parts (e.g. control box and mains cable) and the metal accessible parts – If damage is noticed to any electrical component, turn off at the mains and contact your provider or Drive DeVilbiss Healthcare Ltd. immediately.



Type BF applied part

Applied Part: The parts of the bed that come into physical contact with the user / occupant in order for the bed to carry out its intended function (refer to section 16.2 for a list of applied parts).

Type BF: Applied parts which are electrically isolated from earth and other parts of the medical equipment - Complying with specific requirements for protection against electric shock to EN 60601-1.

7. PARTS IDENTIFICATION

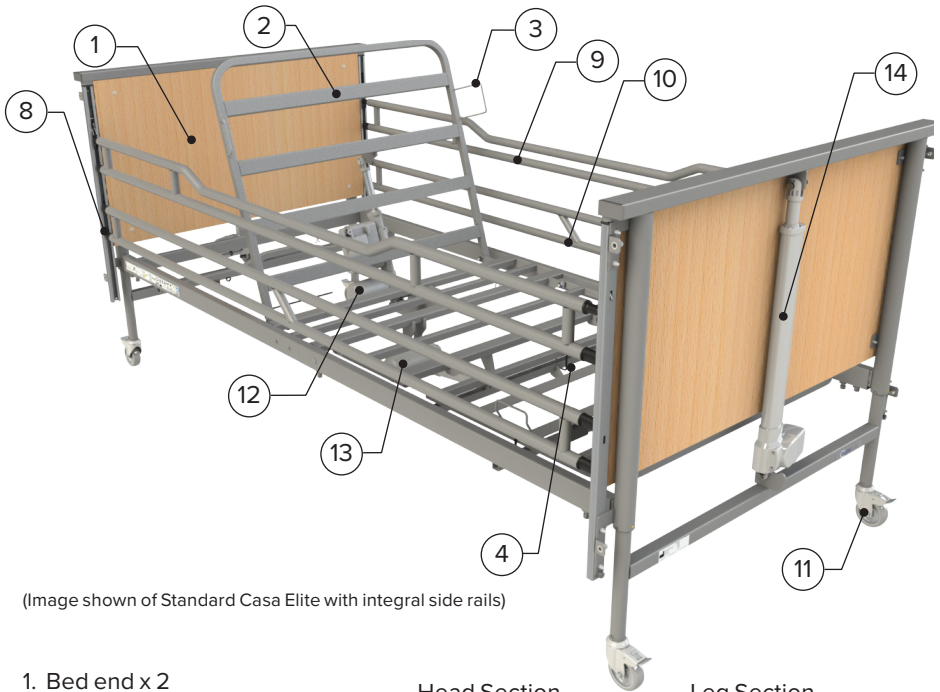

(Image shown of Standard Casa Elite with integral side rails)

1. Bed end x 2
2. Backrest section x 1
3. Mattress side retainer x 4
4. Leg section x 1
5. Transport stand x 2
6. Handset lock key x 1
7. Handset x 1
8. Side rail channel (if fitted) x 4
9. Upper side rail (if fitted) x 2
10. Lower side rail (if fitted) x 2
11. Braked castor x 4
12. Control box/Backrest actuator x 1
13. Leg rest actuator x 1
14. Bed end actuator x 2
15. Head section re-usable cable tie location x 1
16. Leg section re-usable cable tie location x 1
17. Allen key location x 1

Head Section

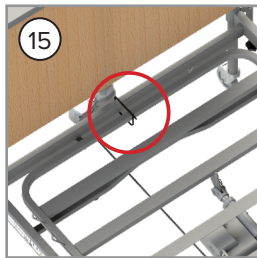

Leg Section

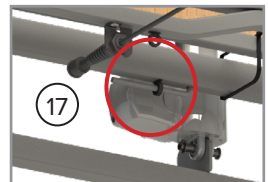
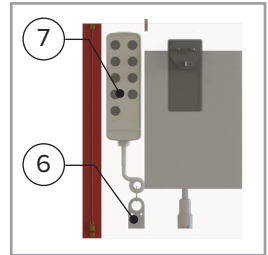
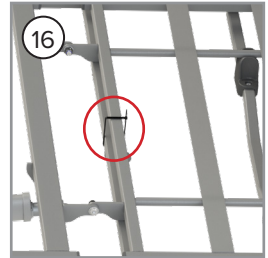

8. BED ASSEMBLY AND PREPARING FOR USE



Warning

- Before attempting to assemble the bed ensure these instructions have been read and fully understood.
- Only qualified personnel are to assemble and prepare the bed for use, if in doubt contact Drive DeVilbiss Healthcare Ltd. or your local distributor.
- Ensure a risk assessment in line with local health and safety policy is undertaken to ensure that staff are not put at risk when performing assembly activities.
- Take care when disassembling the bed from the transport stand, the sections are of considerable weight.

8.1 Removal from the Transport Stand

The assembly procedure is as follows:

- Clear the area intended for the bed of any obstructions and ensure the surface is level.
- Apply the brakes to the castors.
- Loosen the top grub screws with the Allen Key supplied at the head end of the backrest platform on both transport stands. (8.1.1).
- Lift the leg section off the transport stands followed by the head section and carefully place them flat on the floor.
- Loosen the bottom grub screws which secure the bed end to the transport stand on one side only (8.1.2).
- Pull this same bed end away from the transport stands and place carefully against a wall or on the floor. If placing against a wall ensure the castor brakes are applied.

Note: when the transport stands are pulled away neither bed end will be supported.

- Now loosen the remaining screws on the transport stands and carefully pull the other bed end away. The bed has now been separated into its constituent parts.
- Instructions for use and platform clevis pins to be removed from bed kit prior to platform assembly.

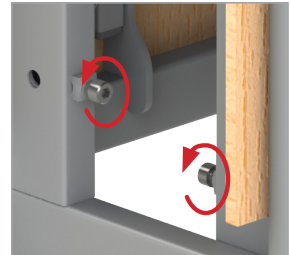

8.1.1 Top grub screws on the transport stand



8.1.2 Bottom grub screws on the transport stand

8.2 Assembling the Bed

- Prior to assembling the bed the backrest actuator of the Casa Elite must be removed and rotated 180° (8.2.1) to change the bed from transport to in use mode. Ensure the mains cable is not in tension or inappropriately entangled around the control box after rotation.
- Lying one of the bed ends flat on the floor, lift one of the mattress platform halves and engage onto the bed end (8.2.3). Adjust the position of the mattress platform half if necessary to ensure it is located centrally onto the bed end and the platform is pushed fully up against the bed end. Tighten the grub screws to lock into position (8.2.2). **Note: If this action is being undertaken by a single person Drive DeVilbiss Healthcare Ltd. recommend that the castors are braked before assembly commences.**
- Repeat for the remaining bed end and mattress platform half.
- Release the brakes on the castors on both bed ends.
- Bring both halves of the bed together (8.2.4) and align each section so that the spigots in the backrest section locate into the open tube ends in the leg section. Now pull the two sections together. Once complete check that the bed ends are still pushed fully up against the bed ends.
- Place the clevis pins from the bed kit through the holes by both central joints with the head of the pin on the outside of the bed. Place the plastic spacer over the end of the pins and insert the 'R' clips from the top of the bed through the hole in the pin (8.2.4) and **tighten the two grub screws.**

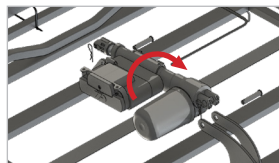

8.2.1 Rotation of backrest actuator



8.2.2 Bed end and backrest assembled

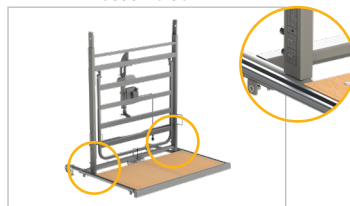

8.2.3 Bed end and backrest section assembled



8.2.4 Bring assembled bed halves together



8.2.5 Clevis pin, spacer, and R clip fitting



Warning

The bed must never be used if the grub screws and/or clevis pins and associated 'R' clips are loose or missing - risk of bed collapse.



Caution

- Ensure all wraps/hooks and loop tape (or similar) securing any of the sections in place are removed prior to operation - damage to the frame could occur.
- Ensure the backrest actuator is rotated in the direction shown (Figure 8.2.1). Incorrect rotation could cause product damage.

8.3 Fitting the Electrical System

- Remove the retaining cable cover to the control box (screwdriver required) (8.3.3). Plug the actuator and handset cables into the control box see 8.3.1 for detail of the control box label.

Note: The plugs only fit into the ports in one orientation. Ensure the cables are plugged fully into the control box.



Warning

- The two bed ends are identical however plugging the actuators into the correct ports is important to ensure the bed ends operate as intended. Tilt function will not work as intended if incorrectly connected.
- Always disconnect the bed from the mains power supply prior to connecting or disconnecting any cables to the control box.

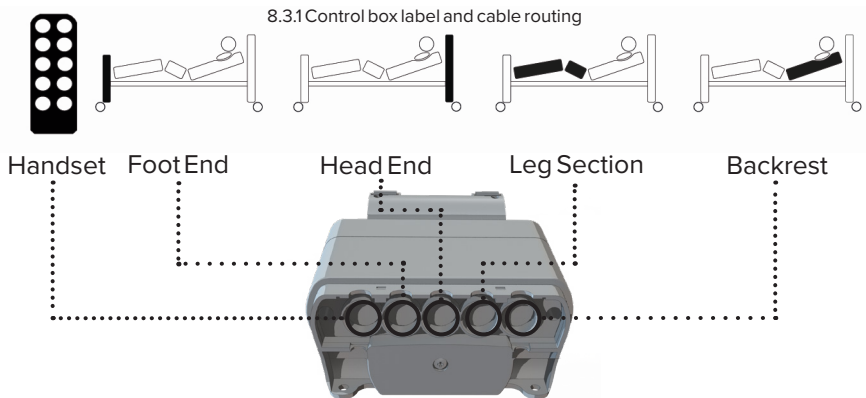

- Once all the cables are connected they are to be secured in place by re-attaching the supplied cable cover to the control box (8.3.3). If removed, the battery cover is fastened into place using the supplied screw (8.3.2). The mains cable exiting the control unit should now be connected to the power supply plug. Take the 2 plugs and push them together, ensuring the connection has been fully made before plugging into the mains (8.3.4)
- Drive the bed to its maximum height then secure the actuator cables in the twist clips under the mattress platform (refer to section 8.4). Ensure each bed end actuator cable has enough free cable to allow full movement of the actuator.

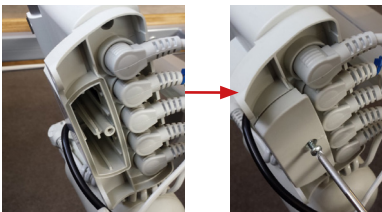

Unscrew/screw the battery cover into place by using the screw provided

8.3.2 Fitting battery cover

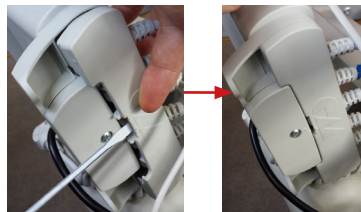

Cable cover unclips/clips into place

8.3.3 Fitting cable cover



8.3.4 Plugging the bed into the mains

8.4 Cable Routing

The cables are to be routed on the bed frame as shown below:

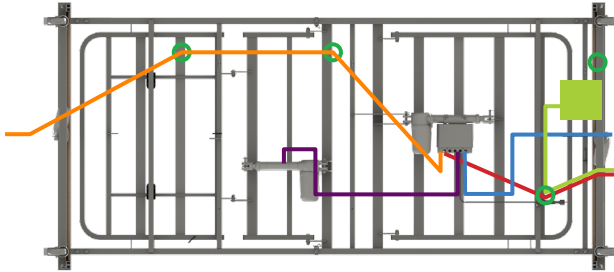

- Cable Clips
- Mains Cable (default)
- Head End Actuator Cable
- Leg Section Actuator Cable
- Foot End Actuator Cable
- Battery Backup Mains Cable (CASA/BATTERY/1 only)

8.4.1 Bed cable routing



Warning

Ensure all cables, in particular the mains cable, are free from moving parts and are not under excessive tension to avoid cable damage - Damaged cables can create a risk of electrocution/fire.

8.5 Ancillary Product Cable Routing

When fitting ancillary electrical equipment the ancillary mains cable is to be routed using the twist cable clips located underneath the bed. These clips are shared with the bed's actuator cables.

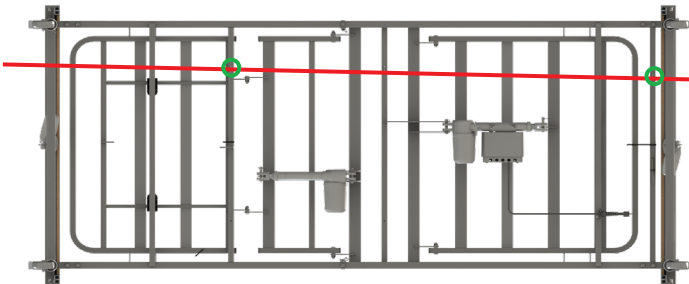

Ancillary product cable routing

8.5.1 Ancillary product cable routing



Warning

Ensure all ancillary cables are free from moving parts and are not under excessive tension to avoid cable damage - damaged cables can create a risk of electrocution/fire.

8.6 Fitting the Side Rails

Ensure the side rails used are the correct length for the beds length (extended length or standard length side rails).

Raise the bed to approximately the midpoint of its height range. Refer to section 9.4 for details of handset operation.

Dipped silver metal side rails are used for illustrative purposes. Other side rails and accessories are available (see section 18). See INSTRUC/RAIL/KIT for more information.



Warning

If there is any doubt about the assembly of the side rails contact the provider of the equipment or Drive DeVilbiss Healthcare Ltd., incorrectly fitted side rails can lead to death.

Note: If the side rail finger blocks are already located inside the side rail channels, remove the finger blocks from just one end of the bed, then proceed to assembly stage 4 below.

1. Unscrew the thumb wheels located at the bottom of each side rail channel.

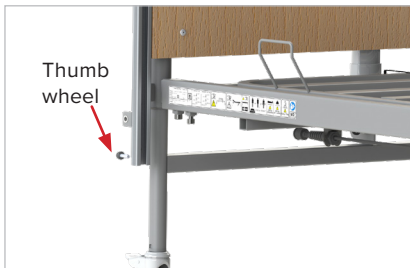

8.6.1 Thumb wheel removed

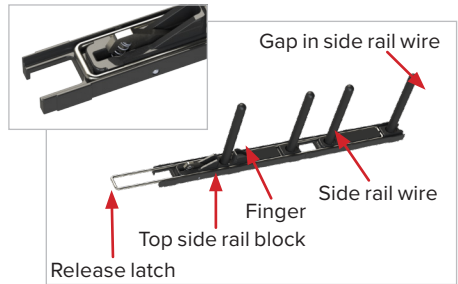

8.6.2 Top side rail block and wire assembly

3. Insert the top side rail block into one of the side rail channels until it latches in the lowest position; note the correct orientation of the block (release latch to top).



8.6.3 Top side rail block latched

4. Slide the top side rail, identified by a bent bar, over the fingers in the top side rail block. This must be oriented so the bent bar is at the top, otherwise assembly will not be possible.

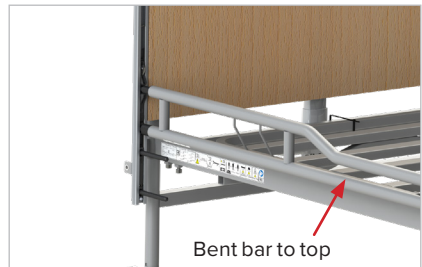

8.6.4 Top side rail inserted
(Side rail shown for reference.
Actual product may vary.)

5. Connect another side rail wire and top side rail block together as described in step 2, and insert the fingers into the vacant end of the top side rail. Lift this top side rail block into the channel until it latches in place.
6. Release the latch on one of the top side rail blocks and steadily lower to allow sufficient space for the bottom side rail block to clip over the lift wire. It is essential that the lift wire is clipped into the bottom side rail block in the correct location.



8.6.5 Top side rail assembled

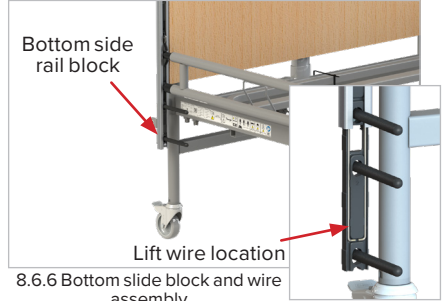

8.6.6 Bottom slide block and wire assembly

7. Slide the bottom side rail, identified by two parallel bars and a diagonal support, over the fingers in the bottom side rail block. This side rail must be oriented with the holes facing downwards. Raise the side rail so it latches in place at one end.
8. Repeat for the other end of the bottom side rail.



8.6.7 Bottom side rail inserted



8.6.8 Side rail raised

9. Reinsert the thumb-wheels into the bottom of each side rail channel to secure the channels in place.
10. Repeat the process for the other side of the bed. Check the side rails operate correctly to confirm that they are correctly assembled. Once assembled check bed ends are still pushed up against the platform fully.



8.6.9 Thumb wheel re-inserted



8.6.10 Side rails fitted

8.7 Side Rails and Mattresses

The Casa Elite can be specified with side rails; refer to section 18 for a comprehensive list of options. When specifying a mattress and side rail combination a clinical assessment of the patient's needs must be carried out in line with local policy.



Warning

- Ensure that any mattresses used are of the correct size and type and have been fitted correctly (see section 18) – incorrect mattress specification could lead to an entrapment and/or falls hazard.
- Ensure the side rails (if fitted) are compatible with the mattress and bed combination (see section 18) - incorrect product combinations could pose an entrapment hazard.

8.8 Side Rail Safety

Drive DeVilbiss Healthcare Ltd. only recommends the use of Drive DeVilbiss Healthcare Ltd. side rails with Drive DeVilbiss Healthcare Ltd. beds. Drive DeVilbiss Healthcare Ltd. does not recommend the use of the Casa Elite bed and the associated side rails when caring for individuals who are less than 146cm in length - It is the equipment provider's responsibility to ensure suitability for use.



Warning

- Whilst every care has been taken to ensure that the design of Drive DeVilbiss Healthcare Ltd side rails meet the relevant safety standards, beds fitted with side rails can still pose a potential risk of death from entrapment and/or asphyxiation.
- All staff responsible for the purchase, selection for use, and the adjustment of bed side rails should be aware of the potential risk of entrapment and asphyxiation when a bed is occupied.
- Care must be taken when positioning and adjusting side rails to ensure that any spaces between the side rails, mattress or bed frame will not allow entrapment of the occupant's head or body. In addition, consideration should be given to the size and physiological condition of the occupant and an assessment undertaken to ensure that the spacing between the bars of the side rails are not wide enough to present a potential risk of entrapment and/or asphyxiation. All staff responsible are to be aware that increased vigilance is required when nursing patients in beds fitted with side rails.

8.9 Checking the Bed

The bed is now fully assembled. Before it is put into use, ensure the bed has been correctly assembled by carrying out the following checks:

- Are the grub screws on the corners of the bed fully tightened?
- Are the two central mattress platform grub screws fully tightened?
- Have the two clevis pins been passed through the bed's central join and secured with 'R' clips and spacers?
- Has all packaging been removed, e.g. cable ties securing the platform sections?
- Are the cables free of all moving parts of the bed and is there sufficient free cable to allow for movement?
- Is the bed clear of obstructions?
- If fitted, are the fixings securing the integral side rail channels fully tightened?
- If fitted, do the integral side rails raise/lower smoothly and lock automatically when raised to the highest position?
- Has a risk assessment been performed on the suitability of the bed (and any ancillary equipment) for the user?

8.10 Fitting Ratchet

The Casa Elite can be specified with a ratchet to adjust the leg section angle; refer to section 18 for a comprehensive list of optional accessories. The ratchet is supplied with a spanner, you will also need the Allen Key provided with Casa Elite bed; refer to section 7 for allen key location on the bed.

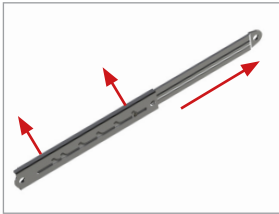

1. Fully extend the ratchet, before offering up to the bed (note ratchet orientation).

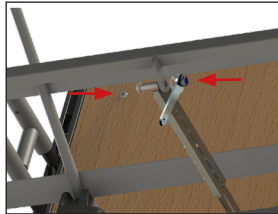

2. Place the screw through the hole on the leg section platform, facing in towards the actuator. Add the white spacer to the screw, slide the ratchet over the screw until flush with the white spacer (note ratchet orientation). Add the white washer, using the Allen key and spanner provided tighten in place with the nyloc nut. This end of the ratchet is now fixed into position.

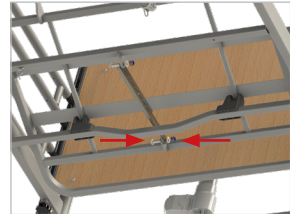

3. Take the loose end of the ratchet and place the remaining screw through the mounting hole facing in towards the actuator. Add the white spacer between the ratchet and bracket on the leg section. Add the white washer on the nut side of the leg section bracket, using the Allen key and spanner provided tighten into place with the nyloc nut. The ratchet is now fixed into position, check operation before use.

8.11 Knee Break/Leg Section

Note: The operation of the leg section is dependent on the position of the ratchets as detailed below.

When the leg section function on the handset is operated the height or angle of the leg section is adjusted, depending on whether or not the leg section ratchet is engaged.

Leg section angle adjustment:

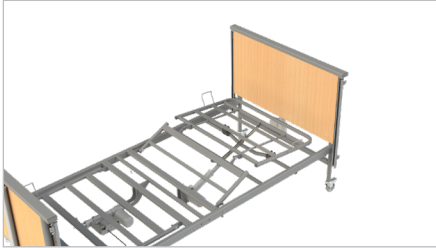

8.11.1 Leg section angle adjustment

Leg section height adjustment:



8.11.2 Leg section height adjustment

To set the bed so that the leg section angle adjustment operates:

- Press the knee break button on the handset to fully lower the leg section. The ratchet will automatically default to the angle adjustment setting when the leg section is fully lowered.

To set the bed so that the leg section height adjustment operates:

- Press the leg section button on the handset to raise the leg section to maximum height.
- Taking hold of the bottom of the foot section, **slowly** lift the section manually so the ratchet engages, stopping when the required angle has been reached.

Note: The ratchet will reset if lifted to its full extent, and will therefore not engage the leg section height adjustment.

- The leg section will now be raised as the leg section is driven up/down. The ratchet will automatically reset when the leg section is fully lowered again, defaulting the leg section to the angle adjustment setting.



Warning

Before attempting to engage/disengage the ratchet mechanism either:

- Ensure there is no load on the foot section or support the foot section with a second able bodied person.



Caution

The leg section is only to be used for the lifting of a patient's legs - any other use may damage the bed frame.

8.12 Lockout Function

The handset is supplied with a lockout function which enables the carer to disable bed functions if they are deemed unsuitable for the occupant. The lockout function on the handset is to be used at the discretion of the carer.

To lock/unlock a function, turn the handset over and insert the handset key provided into the recess and turn to the required position (clockwise to lock, anti-clockwise to unlock).

Note: The handset functions are likely to be in the locked state when the bed is first installed. head down tilt function lockout is only available with the 10 button handset. For accessories please refer to Section 18.

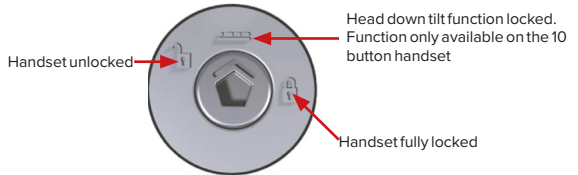

8.13.1 Locking function

As the key is rotated the light will extinguish/illuminate as determined by the lock state. **9 Button Handset (Standard)**

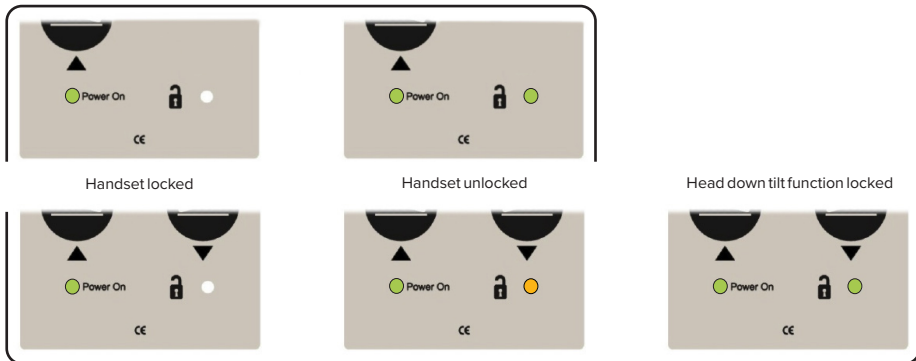

10 Button Handset (Accessory)

Note: When head down tilt function is locked out and the bed is in the foot down tilt position the platform is levelled via the mattress platform raise/lower buttons, take the frame fully up or down until the platform is level.



Warning

- Engage the lockout functions if a patient could be injured due to inadvertent motion of the mattress platform.
- If children, adults who lack capacity or even pets pose a potential risk of intentional or unintentional tampering with the bed the lockout function on the handset is to be used at the discretion of the carer.
- Consideration is to be taken with regards to the storage of the handset lockout key to minimise the risk of it being swallowed or posing a choking hazard to a baby, child, bed occupant or any other person.
- Consideration is to be taken when storing the handset lockout key to minimise the risk of unauthorised users changing the lock setting.

8.13 Installation/Preparing for Use

Prior to operating the bed for the first time the following simple checks must be performed:

- Ensure the bed and all accessories are at room temperature.
- Ensure the bed has been cleaned and disinfected (see section 13).
- Ensure the brakes on the castors have been applied.*
- Before locking the castors, ensure they are aligned so that they run parallel to the length of the bed and inboard so they do not present a trip hazard.
- Ensure the mains cable is plugged into an appropriate mains socket.
- The handset may be in a locked or unlocked state, ensure it is set according to the patient requirements (see section 9.4 for handset operation).
- Using the handset ensure the bed is level (see section 9.4 for handset operation), before positioning the bed according to the patient's needs.

* All four castors should be locked to prevent inadvertent movement of the bed. If the bed will be used in tilt, it is advisable to unlock the foot end castors whilst operating the function to prevent the castors from dragging over the floor during the tilting motion. Once the required tilt position is reached, all castors should be locked.



- Ensure the mains cable is plugged into an appropriate power source at all times.
- Ensure the electrical cables are not in tension, paying particular attention to the mains cable when the bed/backrest travel up/down.
- Ensure that all cables and the handset are clear of all moving parts to prevent damage to the electrical components.
- Inappropriate handling/positioning of the mains cable could cause kinking or shearing of the cable which may lead to exposed live wires - risk of electrocution.
- Drive DeVilbiss Healthcare Ltd. recommend the bed is left in its lowest position when the patient is unattended in order to reduce the risk of injury due to a fall.
- Before operating the bed ensure the patient is positioned appropriately ensuring all limbs are clear of moving parts to reduce the risk of patient injury.
- The mains plug is the disconnect device for the means of isolating the bed from the mains supply, the plug must be accessible at all times.
- Precautions are to be taken when routing cables from external equipment around the bed to ensure that they do not become crushed, trapped or damaged - damaged cables could pose a risk of electrocution/fire.
- A CE marked extension cable must only be used when it is not possible to reach a wall socket with the equipment mains cable – contact Drive DeVilbiss Healthcare Ltd. or the equipment provider for information regarding the safe use of extension cables.
- If an extension cable is used never overload it by plugging in appliances that together will exceed the maximum current rating stated for the extension cable – risk of fire.
- ‘Block’ adaptors should not be used.
- Ensure multiple socket outlets are not positioned under the bed frame - liquids that leak onto such a socket could pose an electrical/fire risk.
- Any electrical component that is part of the bed frame or associated ancillary equipment that is found to be damaged must be removed from service immediately and replaced - damaged electrical components could pose a risk of electrocution/fire.
- Consideration is to be taken in the positioning of the bed cables and handset cable to minimise the risk of accidental strangulation resulting from entanglement of the bed occupant or any other person.



Warning

- After assembly of the bed there should be no parts remaining, however consideration is to be taken in the event of spare components (pins, clips etc.) being evident to minimise the risk of them being swallowed by the bed occupant or any other person; this could pose a choking hazard.
- Keep the bed away from sources of heat and naked flames (e.g. cigarettes, fireplaces, electric fires, fan heaters etc.) – Close proximity could damage the electrical system and/or pose a fire hazard.
- If the bed is being used in conjunction with a hoist ensure the under bed clearances are checked before lowering the bed to minimum height - risk of frames clashing.



Caution

- If the bed has come from a storage/transport temperature environment near to the minimum or maximum values stated allow the bed to adjust to room temperature for a minimum of 2 hours prior to plugging the bed into the mains supply - risk of electrical system damage if operated outside of the recommended temperatures.
- Do not use the side rails to move the bed – side rail/bed frame could be damaged.
- Avoid placing the bed frame in direct sunlight - direct sunlight could damage the electrical system and/or cause the bed to fade in colour over time, including fading of the bed labelling.
- Avoid placing the bed frame in a moisture rich environment – prolonged exposure to moisture could damage the electrical system and/or have a detrimental affect on the bed frame components.
- Special care should be taken when fitting an air mattress to the bed as incorrect fitting could damage the bed frame.
- The bed is not designed to run off battery power for long periods (with CASA/BATTERY/1 only) and should always be plugged into the mains supply during normal use - allowing the battery to discharge fully may impair its performance.
- When the bed is operated, ensure that obstacles such as over bed tables and other furniture are not causing an obstruction.
- Ensure the bed is positioned an appropriate distance from walls/ other furniture to prevent equipment damage when operating the bed (particularly when operating in tilt)
- Special precautions regarding EMC need to be taken, the bed is to be installed and put into service according to the EMC information provided in section 17.

9. OPERATION OF THE BED

9.1 Operational Limits

- Ambient temperature: +10°C to +40°C
- Humidity: 30% - 75%
- Atmospheric pressure: 800 hPa to 1060 hPa (altitude \leq 2000m)

9.2 Brake System

The bed has four braked castors.

- To apply the brakes: Press the brake pedal down on each of the four castors using the foot - Drive DeVilbiss Healthcare Ltd. recommend appropriate footwear is worn to operate the pedal safely.
- To release the brakes: Push the brake release pedal down on each of the four castors (located on top of the castor).

When the bed is in use Drive DeVilbiss Healthcare Ltd. recommend all brakes are applied in normal use – Foot end castors should be unlocked if the tilt function is to be used.

9.3 Operating the Side Rails (Where Fitted)



Warning

- Ensure the side rails are locked in place at all times when in the raised position to prevent injury or entrapment.
- When raising/lowering the side rails ensure they are free from limbs, to prevent injury or entrapment.
- When exiting the bed the side rails are not to be held on to - risk of finger entrapment/crushing hazard if weight of patient's legs allows side rails to flex downwards and close the gap between the rails.



Caution

- Do not use the side rails to move the bed – side rail/bed frame could be damaged.
- Do not use the side rails as a positioning or lifting aid – side rail and/or bed frame could be damaged.
- When lowering, do not drop the side rail - side rail and/or bed frame could be damaged.

This information refers to the operation of the integral dipped metal silver side rails. For details of how to operate a different type of side rail, refer to your side rail instructions for use.

To lower the integral side rails:

1. Lift one end of the top side rail upwards.
2. Depress the release latch at the raised end of the side rail whilst holding the side rail up.
3. Gently lower the side rail until fully down at one end. The release latch can be released after the side rail has begun to lower.
4. Repeat the process at the opposite end of the bed.

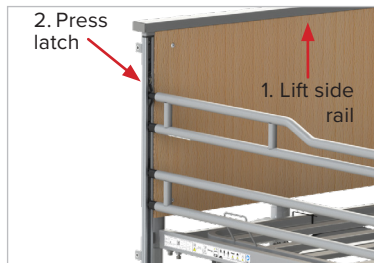

9.3.1 Lowering the side rails

To raise the integral side rails:

1. Lift the upper side rail until it is heard to latch into position at the top height at both ends of the bed.

9.4 Electrical Operation

The bed is supplied with an easy to use handset. The handset may be operated by the occupant or carer. If the carer is to operate the bed ensure that the occupant is made aware of the action(s) about to take place.

Holding down of the relevant button causes the desired function to operate, releasing the button causes the operation to terminate and all movement to stop.



Warning

- Ensure a risk assessment is undertaken to ensure the suitability of the occupant using the handset.
- The handset cable must also be considered in regards to the risk of accidental strangulation of the bed occupant or any other person - If the cable introduces an unacceptable risk it is recommended that the handset is removed from the bed.
- Before lowering the bed ensure no one is in close proximity to the underside of the bed frame - risk of crushing.
- Before lowering the bed ensure feet/limbs are kept away from the castor pedals - risk of crushing (Casa Elite Low only).
- As standard, the handset provided omits a head down tilt function for safety reasons. If the head down tilt function is required a replacement handset can be purchased featuring this function. Please refer to Section 18 for the part code, refer to the contact information in Section 2 to order or to request further information - Drive DeVilbiss Healthcare Ltd. recommend the use of the standard handset when the bed is being used in a domestic environment.
- The mains plug is the disconnect device for the means of isolating the bed from the mains supply; the plug must be accessible at all times. If the mains plug is inaccessible, separate the connection halves of the mains cable (see figure 8.3.4).



Caution

- If the bed is continuously used for an extended period of time and it exceeds the duty cycle the control box may become temporarily disabled or irreparably damaged – see section 16.2 for further detail.
- Before lowering the bed ensure the area underneath is free from objects/obstructions - risk of damage to the bed and object/obstruction.
- The backrest is only to be used for the raising and lowering of the patients back - any other use may damage the frame.
- Failure to return the actuator to its original position could result in product damage.

9 Button Handset (Standard)

10 Button Handset (Accessory)

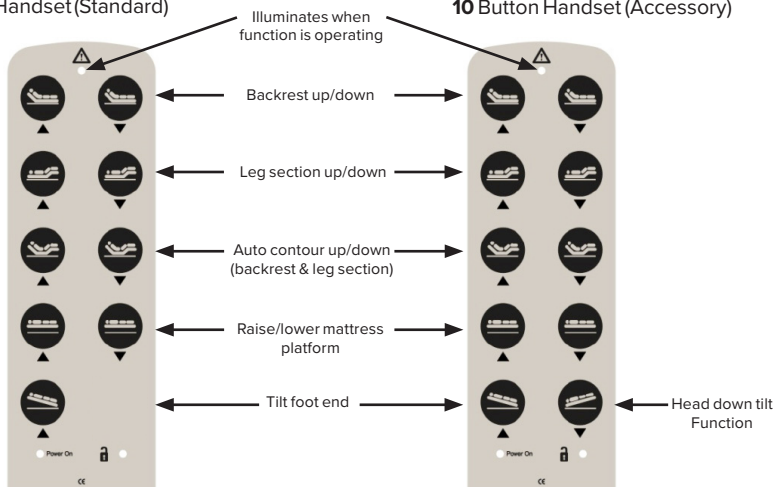

10. ASSEMBLY ONTO THE TRANSPORT STANDS

When the bed is in the foot down tilt position (or head down tilt if a 10 button handset is used) the platform is levelled via the mattress platform raise/lower buttons to take the frame fully up or down until the platform is level.



Warning

- Before attempting to assemble the bed onto the transport stands ensure these instructions have been read and fully understood.
- Ensure a risk assessment in line with local health and safety policy is undertaken to ensure that staff are not put at risk when performing assembly activities.
- Take care when assembling the bed onto the transport stands, the sections are of considerable weight (see section 16).

Side Rails (if fitted)

- Raise/lower the mattress platform to approximately its middle height, ensuring the platform is level.
- Remove the thumb wheel from each side rail channel.
- Carefully lower the side rail (the lower slide block will partially protrude from the channel).
- Unlatch the slide blocks at one end of the bed and, whilst lowering and supporting the side rails, carefully remove the slide blocks from the bottom of the channel.
- Whilst supporting the side rails, remove them from the slide block fingers at both ends, and place them on the floor, then reinsert the slide block assemblies into the side rail channel for storage. Refit the thumb wheel to the bottom of the side rail channel.



10.1 Slide block assembly

Electrics

- Flatten (and lower) the bed to its minimum height (see section 9.4).
- Unplug the mains cable from the mains socket.
- Remove the retaining clips from the control box.
- Unplug the bed end and leg section actuator cables from the control box.
- Detach the cables from the cable routing clips on the underside of the bed.
- Return the backrest actuator to its original position by flipping it 180° so that the top of the actuator is facing downwards (see section 8.2.1). Ensure the mains cable is not in tension or inappropriately entangled around the control box after rotation.



Caution

- Failure to return the backrest actuator to its original position may result in product damage.

Bed Frame

- Using the cable ties that first came with the bed, secure the moving parts of the backrest and leg section to the bed frame halves. See section 7 for cable tie locations.
- Retrieve the transport stands from storage.
- Release the castor brakes.
- Loosen the grub screws in the middle of the bed frame and remove the clevis pins, 'R' clips and spacers from the central joint.
- Whilst supporting both halves of the bed frame near the centre of the bed, split the bed in half by carefully pulling the sections apart and gently lower onto the floor - this may be considered easier with the help of a second able bodied person.
- Apply the castor brakes on the bed ends.
- On one bed end, loosen both grub screws with the Allen key provided.
- Whilst supporting the bed end, lift the platform half away from the bed end and gently position both sections appropriately.
- Repeat for the remaining half of the bed.

Assembling onto the Transport Stand

- Slide both transport stands onto one bed end, taking care to ensure the brackets are both oriented correctly.
- Tighten the grub screws with the Allen key provided to lock into position.
- Slide the remaining bed end onto the transport stands and tighten both remaining grub screws to lock into position (10.2).
- Before lifting the backrest and leg section frames, ensure the moving parts have been secured with cable ties or similar.
- Carefully lift the leg section and lower onto the slotted vertical tubes of the transport stands, ensuring the electrics are facing inwards. The leg section must be fitted to the transport stands before the backrest section (10.3).
- Carefully lift the backrest section and lower the spigots through the larger open tubes on the transport stands, ensuring the electrics are facing inwards.

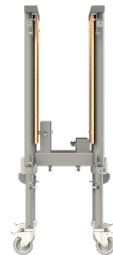

10.2 Transport stand base



10.3 Leg section on transport stands



10.4 Clevis pin, bush & R-clip fitting

- Tighten all grub screws.
- Insert the clevis pins through the transport stands and leg section and secure with the 'R' clips and spacers. (10.4)
- Ensure the instructions for use, control box clip and handset locking key are safely stored, and that all cabling is neatly wrapped around the relevant bed sections and is not dragging on the floor or under excess tension (10.5).



10.5 Bed on transport stand



Warning

- The bed must never be moved on the transport stand without all sections locked into place as mentioned above - risk of bed collapse.
- Ensure moving parts have been secured with the re-useable cable ties provided - risk of sections moving in an uncontrolled manner.

11. POWER FAILURES

The bed does not have battery backup functionality unless you have purchased the battery backup accessory (CASA/BATTERY/1). This can be identified by a battery box fastened to the backrest mattress platform. In the event of a power failure the bed will not function, resulting in the backrest and/or leg section remaining in the last position being used (for example, a raised position).

The backrest and leg section are operated via two individual actuators that are located underneath the mattress platform. If either the backrest or leg section actuator is raised in the event of a power failure and needs to be lowered:

- Locate the actuator supporting the relevant section.
- Hold/support the section - It is recommended that two carers support the section*. Remove the pin that holds the top of the actuator in place, allow the actuator to gently swing down whilst still connected at the base.
- Gently lower the section(s) to the flattened position.
- Function that has been manually lowered should be locked out on the handset until the actuator is reattached.



Warning

- * If the section is to be lowered with a patient in the bed, a risk assessment should be carried out to determine the weight applied to the backrest and whether it is possible to lower the section safely. It is recommended that two carers support the section prior to lowering. When the pins are removed there is nothing supporting the section, the carer(s) holding the frame must be ready to support the weight on removal of the pin.
- The mattress retainers are not intended to be used to lift or support the backrest - risk of retainer damage and backrest falling.

For beds that feature battery backup functionality, the bed can be operated normally via the handset in the event of a power failure. The bed functions may operate at a slower speed when the bed is operating from the battery.

12. BATTERY CHARACTERISTICS (CASA/BATTERY/1 ONLY)

The internal battery trickle charges whilst the bed is plugged into the mains supply to keep it in a continually charged state, the bed will continue to operate normally whilst charging. There is no audible or visual signal to identify when the battery is charging or in use.



Warning

Ensure the battery is not exposed to direct sunlight or a secondary heat source - Direct heating of the battery via an external source could pose a risk of fire or cause an explosion.



Caution

The battery is not to be used in normal use (i.e. bed disconnected from the mains supply) - battery life expectancy may be reduced.

13. DECONTAMINATION

Infection control and routine cleaning must be carried out in accordance with your local infection control policy or regulatory body.

It is advisable to remove any accessories that are fastened to the bed. These instructions apply to the bed and all accessories, excluding pads and mattresses.



Warning

- Always disconnect the bed from the main power supply prior to cleaning.
- Ensure all ports on the electrical system (control box and actuators) have cable plugs fully inserted to maintain the IP rating.
- Regular cleaning and disinfection of the bed frame and relevant accessories will help to prevent the risk of infection to the occupant and/or carer.
- Prior to transferring the bed frame/accessory to another user ensure it has been cleaned and disinfected using the method as detailed below to help prevent the risk of cross infection.

13.1 Cleaning and Disinfection Guidelines

General Cleaning:

- The bed should be cleaned by starting with the cleanest parts of the bed and systematically moving to the dirtiest parts. Extra care should be taken around areas where excess dirt or dust may gather.
- The cloth should be changed during the cleaning process if it becomes soiled.
- Wipe down with a clean cloth moistened with a mild detergent and dilute with warm water (40°C).
- Rinse with cold, clean water and a clean cloth, and allow to fully dry before use.

Decontamination:

- Mop up any fluid with paper towels.
- Wipe bed down using cold clean water.
- Wipe down with a 0.1% Chlorine solution (1,000ppm) in cold water.
- Rinse with cold clean water and a clean cloth and allow to fully dry before use. Always ensure the cleaned parts are allowed to dry before putting the mattress back in place.

In cases of blood spills or other bodily fluids it is recommended that a 1% Chlorine solution (10,000ppm) is used instead.

Note: If any of the stages stated above are omitted or combined it will reduce the effectiveness of the clean.



Caution

The use of neat bleach or similar surface cleaners is not recommended as damage may be caused to the cleaned surfaces.

13.2 Steam Cleaning

The Casa Elite can be dry steam cleaned, the individual manufacturer's instructions should be followed when using a steam cleaner and the following precautions observed:

- Avoid directing steam directly at electrical components and reduce steam pressure when cleaning near electrical items and connections.
- Avoid directing steam directly at wooden components and reduce steam pressure when cleaning near wooden components.
- Use soft brushes and wiper cloths as recommended by the steam cleaner manufacturer.
- Do not use excessive force or steam pressure on labels.
- Ensure the bed is dry and all debris from the cleaning process has been removed prior to reuse.
- Ensure all electrical functions operate as normal once the bed has been cleaned and dried.



Caution

Do not use high pressure hoses on the bed as they could cause damage to the electrical components.

14. MAINTENANCE

14.1 General Inspection

Drive DeVilbiss Healthcare Ltd. recommends that authorised personnel perform frequent visual and operational inspections. If there are any signs of damage or the bed is not performing as it should withdraw it from service until the bed has been repaired and is fit for use again.

As a minimum, on a monthly basis check to ensure that:

- The bed operates as per its intended purpose.
- All parts are present.
- All fixtures and fittings are tight.
- The frame is mechanically sound, with no cracking, particularly around welded areas.
- No parts show signs of excessive wear.
- The electrical components display no sign of damage - if so turn off at the mains and remove the bed from use immediately.
- The bed is cleaned following the guidelines in these instructions for use.

14.2 Fault Finding

Listed below are a set of electrical faults that may occur within the service life of the bed. If a fault does occur please try the following suggestions, as these may help in diagnosing the fault.

Fault	Possible Cause	Remedy
Electrical function(s) do not work	Functions locked out on handset	Unlock function(s) - see section 8.12
	Mains cable halves not connected or plugged into the wall	Check to see if the mains cable is plugged into the wall and both halves are connected
	Actuator/handset cables not plugged in	Check plug connections on the control box and actuators
	Damage to electrical component(s)	Turn off at the mains and contact an approved service engineer
	Heavy load on the bed and the duty cycle has been exceeded	If the control box has exceeded its duty cycle, permanent damage will have occurred, a replacement control box will be required
Electrical function(s) working slowly	Heavy load on the bed	Remove load
	Bed is operating on battery power (CASA/BATTERY/1 only)	Check mains cable is plugged in at both ends and turned on (power light will be visible on control box)
Incorrect functions work when handset operated	Cables plugged into incorrect ports on control box	Review cables and graphic on control box to assess if connections are correct

14.3 Servicing

Only authorised service personnel or Drive DeVilbiss Healthcare Ltd. service engineers should carry out repairs or service activities. Failure to do so may result in the manufacturer's warranty becoming void. **The bed must be serviced once yearly, as a minimum.**



Warning

- Failure to carry out the following checks at the stated frequency could negatively influence the essential performance of the bed and as a result put the patient at risk.
- Always disconnect the bed from the mains power supply prior to performing any maintenance procedures (when not checking electrical functions).
- Modification of the bed frame is not allowed without the permission of Drive DeVilbiss Healthcare Ltd. - a hazard could be introduced.
- The bed should be vacated by the patient before any maintenance or inspection takes place. If it is not possible due to the patient's mobility, a risk assessment should be carried out, and if deemed safe to proceed, care should be taken for the service engineer to avoid contact with the patient when working on electrical items.
- Only Drive DeVilbiss Healthcare Ltd. approved components, specified for the Casa Elite and Casa Elite Low beds, should be used - if in doubt contact Drive DeVilbiss Healthcare Ltd. or your local distributor.
- Electrical system components are only to be replaced by authorised service personnel or a Drive DeVilbiss Healthcare Ltd. service engineer.
- Never attempt to re-wire any components.
- Battery packs may emit an increased amount of flammable gas as they age - risk of explosion/fire. Drive DeVilbiss Healthcare Ltd. advise that batteries are replaced every 4 years or sooner (CASA/BATTERY/1 only).

To maintain the bed's essential performance the following checks must be performed:

- Check that all electrical functions operate correctly on the handset.
- Check that all electrical components and cables are in good condition - If not turn off at the mains and remove bed from use until replacement parts are available.
- Check the retaining clip is fastened to the control box, securing the electrical cables in place.
- Check that all four mattress side retainers are present, any missing retainers should be replaced before the bed is used.

- Check that all nuts, bolts and fasteners are tight and that none are missing or incomplete.
- Check that all grub screws are present.
- Check that the backrest and leg rest functions (angle and height adjustment modes) work correctly.
- Check the castors lock/unlock correctly and that when locked the castors do not swivel or roll.
- Check that all product labels are present and intact.
- Check that the frame is mechanically sound with no cracking around the welds, bending of tubes etc.
- Check that the wooden components are free from cracks or deformation.
- Raise and lower the side rails. Check that they move smoothly.
- If side rails are fitted, check that the lock on the side rails automatically engages when the side rails are raised.
- If any gaps appear to be outside of specification remove the bed from use until the dimension of the gap in question has been confirmed.
- For beds fitted with battery backup (CASA/BATTERY/1) check that the battery is capable of suitably powering the bed.
- If in doubt about the correct replacement of a component contact Drive DeVilbiss Healthcare Ltd. or your local distributor.
- Refer to the service manual for part codes and assembly detail. Copies are available from Drive DeVilbiss Healthcare Ltd. Contact details can be found in section 2.

15. DISPOSAL OF PARTS

- When the bed frame, any associated accessories and/or the electrical system have come to the end of its useful life, follow local recycling and W.E.E.E. (waste electrical and electronic equipment) policies - For further information contact Drive DeVilbiss Healthcare Ltd. (see section 2).
- The electrical system on the bed frame is not to be disposed of in general municipal waste. Some of the electrical components could be harmful to the environment and where viable the components can be recovered and reused/recycled.
- The steel, wood and plastic components are also to be separated and disposed of following the local recycling policy as these can also be recovered and recycled.



Warning

The bed and any associated accessories are to be decontaminated before disposal to avoid risk of cross contamination.

16. SPECIFICATION

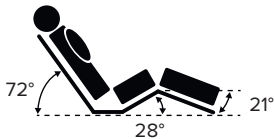
16.1 Bed Data	CASA ELITE	CASA ELITE LOW
Product code	CASA/H/STD/BECH*	CASA/H/LOW/BECH*
	CASA/C/STD/BECH*	CASA/C/LOW/BECH*
Overall length	2140mm	
Overall width (without side rail channels fitted)	1025mm	
Mattress platform height	386 - 806mm	192-612mm
Under bed clearance (to underside of frame when bed is lowered)	342mm	150mm
Under bed clearance (to underside of actuator when bed is lowered)	237mm	47mm
Mattress platform length	2002mm	
Mattress platform width	907mm	
Foot down tilt	0 - 11°	
Mattress platform angles (max)		
Safe working load	200 kg (31½ stone)	
Maximum patient weight	165 kg (26 stone)	
Shock and vibration	To be used on a flat level floor (e.g. vinyl/carpet/laminate based)	
UV	Intended for indoor use only	
Application environment	3 & 4	

Product Code	CASA/C/STD/BECH*	CASA/H/STD/BECH*	
	CASA/C/LOW/BECH*	CASA/H/LOW/BECH*	
Product weight** (on transport stand)	73.35kg	63.35 kg	
Part weights**	Leg section	16.08 kg	16.08 kg
	Backrest	17.74 kg	17.74 kg
	Bed ends (each)	19.02 kg	14.03 kg

* Casa bed varieties include Home Care (H) with uncovered ends and Care Home (C) with timber covered ends. Timber covered ends are also available as an accessory. Refer to Section 18 for more information.

The Casa Elite has a Beech facade as standard, but is available in three colour options: Use **BECH** for Beech, **LOAK** for Light Oak and **WALN** for Walnut, when ordering your bed.

** Device weights measured by manufacturer. Due to tolerances in the device components, device weights may differ slightly on a product to product basis.



Warning

- As standard, the handset provided omits the head down tilt function for safety reasons. If head down tilt functionality is required, a replacement handset can be purchased featuring this function, however the customer should be aware that the Trendelenburg angle requirements EN 60601-2-52 are not achieved. Please refer to section 18 for the part code, and to the contact information in section 2 to order or to request further information - Drive DeVilbiss Healthcare recommend the use of the standard handset when the bed is being used in a domestic environment.
- The Casa Elite Low does not meet the upper height and under bed clearance requirements of EN 60601-2-52, if patient requirements are such that the height range is deemed to pose a potential hazard the Casa Elite should be used instead, please refer to the contact information in section 2 to request further information.

16.2 Electrical Data

	Power Supply Plug
Voltage in:	100-240V, 50/60Hz
Current in:	2A - 1.2A
Electric shock protection:	Class II

Duty cycle:* 10%
2 mins of continuous use followed by **18 mins** not in use.

* Electrically operated beds are intended to be operated intermittently rather than continuously. If the bed is operated continuously for up to 2 minutes it must then be left for at least 18 minutes before reuse to allow the electrical system to cool sufficiently. **If the bed is continuously used for an extended period of time and it exceeds the duty cycle the control box may become temporarily disabled or irreparably damaged.**

Safety standards: EN 60601-1
 EN 60601-1-11
 EN 60601-2-52

Electrical shock prevention:



Applied parts: Mattress platform
 Profiling sections
 Bed ends
 Handset
 Side rails

Liquid ingress protection: IPX4 - Splash resistant

Battery backup: Individual battery non replaceable
 (Contact bed provider for battery part code)

Noise level: <65 dB(A) max

Environmental conditions:

	Operational Limits*	Transport/Storage Limits*
Ambient Temperature	+10°C to +40°C	-20°C to +50°C
Humidity	30% - 75%	30% - 75%
Atmospheric Pressure	800 to 1060hPa	800 to 1060hPa
Altitude	≤ 2000m	≤ 2000m

* Always ensure the bed is brought up/down to room temperature before plugging in and operating - Drive DeVilbiss Healthcare Ltd. recommend the bed is left for a period of two hours or more to reach room temperature.

When operating the bed in an ambient room temperature of 40,0 °C if any of the actuators or the control box need to be touched ensure that any contact is for no more than 1 minute. If the temperature of the actuators or control box begins to feel uncomfortable let go immediately. If there is a specific need to contact these components in such conditions ensure the bed is not operated for 2 hours, to allow the components to cool down, and if safe to do so switch off at the wall.

17. ELECTROMAGNETIC COMPATIBILITY (EMC)

The Casa Elite/Casa Elite Low electrical system has been designed to meet the EMC requirements of EN 60601-1-2 however it may still be affected by or emit harmful radio frequency (RF) energy. The RF emissions from the electrical system are very low and are not likely to cause any interference to nearby electronic equipment, however interference to sensitive equipment is still possible. Likewise if the immunity limits of the electrical system are exceeded the system may be seen to operate abnormally.

If the bed or any alternative equipment is found to be operating abnormally turn off the piece of equipment that is believed to be causing the interference (if possible) to identify the source of the RF energy. Once identified mitigation measures are to be taken, such as the separation distances being increased and/or the device(s) being re-orientated.

If the bed continues to operate abnormally turn off at the mains supply and contact Drive DeVilbiss Healthcare Ltd. or your local distributor (see section 2).

For specific emissions and immunity information relating to the bed, please contact Drive DeVilbiss Healthcare Ltd or your local distributor (section 2).



Warning

- The bed should not be used adjacent to or stacked with other medical electrical equipment, where viable. If adjacent or stacked use is necessary, the bed and associated medical electrical equipment should be observed to verify normal operation - if not taken in to account, abnormal operation could occur.
- Use of accessories and cables other than those specified or provided by Drive DeVilbiss Healthcare could result in increased electromagnetic emissions or decreased electromagnetic immunity of the bed and result in improper operation.
- Portable RF communications equipment (including peripherals such as antenna cables and external antennas) should be used no closer than 30cm to any part of the bed (including its cables), otherwise a degradation in performance could result.

18. ACCESSORIES

NOTE: When ordering accessories please state the colour code in place of **COLOUR**.

METAL SIDE RAILS AND SIDE RAIL PADS	CODE
METAL DIPPED RAIL ACCESSORIES Integral metal dipped side rails (no finger kits) Metal side rail pads Integral extended metal dipped side rails (no finger kits) Extended metal side rail pads Integral side rail finger kits (4 pack)	RAIL/M/D/S SOLITE/PRO/SR/PAD RAIL/M/D/EX/S SOLITE/PRO/SR/EXT/PAD RAIL/FK
METAL STRAIGHT RAIL ACCESSORIES Integral metal non-dipped side rails (no finger kits) Metal side rail pads Integral extended metal non-dipped side rails (no finger kits) Extended metal side rail pads Integral side rail finger kits (4 pack)	RAIL/M/ND/S SOLITE/PRO/SR/PAD RAIL/M/ND/EX/S SOLITE/PRO/SR/EXT/PAD RAIL/FK
METAL RAIL EXTENSIONS Integral metal side rail height extension Integral metal side rail height extension with removable foot section Integral metal side rail height extension pads	RAIL/M/HEX/S RAIL/M/HEX/RF/S SOLITE/PRO/SR/HE/1/PAD
GRAB HANDLES	CODE
Standard grab handle	1210/GRAB
Short grab handle*	1216/GRAB
WOODEN SIDE RAILS AND SIDE RAIL PADS	CODE
WOODEN RAIL ACCESSORIES** Integral wooden rail (no finger kits) × 4 required per set Wooden side rail pads Integral extended wooden rail (no finger kits) × 4 required per set Wooden extended side rail pads Integral wooden side rail height extension Integral wooden side rail height extension kit * Integral side rail finger kits (4 pack)	RAIL/W/ COLOUR 1275/PS RAIL/W/EX/ COLOUR 1275/PS/EXT RAIL/W/HE/EX/ COLOUR RAIL/W/K/HEEX/ COLOUR RAIL/FK

* 1216/GRAB is incompatible with side rails fitted to the bed. If side rails are required, please order 1210/GRAB.

** Integral wooden side rail accessories are available in the following choice of colours:
Beech (**BECH**), Light Oak (**LOAK**), Walnut (**WALN**)

SIDE RAILS AND SIDE RAIL PADS	CODE
OTHER	
Grange side rail	GRANGE/SR
Grange side rail pads	1316/PS/CREAM



Warning

Accessories that have not been approved or designed for use with the bed are not be used - A hazard could be introduced due to product combination incompatibility.

OTHER ACCESSORIES	CODE
Lifting pole	SOLITE/LASER/LP/1
Infusion (drip) pole	BED/DP
10 Button handset (head down tilt function)	CONTROL/130
Battery back up	CASA/BATTERY/1
Bed extension (+160mm mattress platform length)	CASA/BED/EX
Pump bracket	CASA/PUMPBKT
Bed End Wooden Surround*	CASA/BE/COLOUR
Lifting pole socket, left hand**	CASA/LPSOCKET/LH
Lifting pole socket, right hand**	CASA/LPSOCKET/RH
Cradle Pad	SOLITE/PRO/EPS/PAD
Head and foot end pad	SOLITE/PRO/HF/PAD
Leg section ratchet	BED/RATCHET
Bed bump stop	BED/BUMPSTOP
Community bed plastic bag accessory	BAG/COM/BED/P

* The Casa Elite Bed End Wooden Surround accessory is available in the following choice of colours:

Beech (**BECH**), Light Oak (**LOAK**), Walnut (**WALN**).

** Left and right handed accessories are determined when laying supine in the bed. Characteristics of accessories can be found in their relevant instructions for use.

Please note cautions and warnings on page 48. The bed has been tested and approved with the following mattresses:

The below table highlights the current Drive DeVilbiss Healthcare mattress range. See section 18.1 for mattress compatibility tables. For more information contact Drive DeVilbiss healthcare (see section 2).

Mattress Type	Code	Length	Width	Thickness
Foam Mattresses				
<i>Standard Range</i>				
Softrest VE	MAT/SOFT/VE	1990mm	880mm	152mm
Softrest	MAT/SOFT			
Softrest Contour	MAT/SOFT/CON			
Permaflex ST	MAT/SOFT/PERM			
MAT 10	MAT10BE	1980mm	900mm	127mm
MAT 20	MAT20BE			152mm
MAT 30	MAT30HS			
<i>Premium Range</i>				
Permaflex Plus	MAT/ACCL/PERM/PLUS	1990mm	880mm	152mm
Permaflex HSF	MAT/ACCL/PERM/HSF			
Acclaim VE	MAT/ACCL/VE			
Memaflex	MAT/ACCL/MF			
Foam Mattress Extensions				
Softrest	MAT/SOFT/EX	180mm	880mm	152mm
Softrest (with straps)	MAT/SOFT/EX/STRAPS			
Acclaim VE	MAT/ACCL/VE/EX/STRAPS			
Dynamic Pumps and Mattresses				
Eros Dial Pump	EROS/PUMP	FOR USE WITH OVERLAY/MAT OR FULL/MAT		
Theia Digital Pump	THEIA/PUMP			
Drive Dynamic Overlay	OVERLAY/MAT	2000mm	990mm	127mm
Drive Air on Foam	FULL/MAT			177mm
Dynamic Systems				
Simple Air	1001270001	2000mm	880mm	200mm
Atlas	DYN/DIG/ATLAS	2020mm		
Apollo	DYN/DIG/APOLLO	2000mm		
Artemis	DYN/DIG/ARTEMIS			
Athena	DYN/DIG/ATHENA		900mm	250mm

18.1 Mattress/Side Rail Compatibility Charts

Mattress Type	Code	RAIL/M/D/S	RAIL/M/ND/S	RAIL/M/HEX/S
Foam Mattresses				
<i>Standard Range</i>				
Softrest VE	MAT/SOFT/VE	✓	✓	✓
Softrest	MAT/SOFT	✓	✓	✓
Softrest Contour	MAT/SOFT/CON	✓	✓	✓
Permaflex ST	MAT/SOFT/PERM	✓	✓	✓
MAT 10	MAT10BE	✓	-	✓
MAT 20	MAT20BE	✓	✓	✓
MAT 30	MAT30HS	✓	✓	✓
<i>Premium Range</i>				
Permaflex Plus	MAT/ACCL/PERM/PLUS	✓	✓	✓
Permaflex HSF	MAT/ACCL/PERM/HSF	✓	✓	✓
Acclaim VE	MAT/ACCL/VE	✓	✓	✓
Memaflex	MAT/ACCL/MF	✓	✓	✓
Foam Mattress Extensions				
Softrest	MAT/SOFT/EX	✓	✓	✓
Softrest (with straps)	MAT/SOFT/EX/STRAPS	✓	✓	✓
Acclaim VE	MAT/ACCL/VE/EX/STRAPS	✓	✓	✓
Dynamic Pumps and Mattresses				
Eros Dial Pump	EROS/PUMP	✓*	✓*	✓
Theia Digital Pump	THIEA/PUMP	✓*	✓*	✓
Drive Dynamic Overlay	OVERLAY/MAT	✓*	✓*	✓
Drive Air on Foam	FULL/MAT	✓*	✓*	✓
Dynamic Systems				
Simple Air	1001270001	✓*	✓*	✓
Atlas	DYN/DIG/ATLAS	✓*	✓*	✓
Apollo	DYN/DIG/APOLLO	✓*	✓*	✓
Artemis	DYN/DIG/ARTEMIS	✓*	✓*	✓
Athena	DYN/DIG/ATHENA	✓*	✓*	✓
Rails and Pads				
Standard Grab Handle	1210/GRAB	✓**	✓**	-
Short Grab Handle	1216/GRAB	-	-	-
Padded Side	METAL/SR/PS	✓	✓	-
Padded Side	METAL/SR/HEX/PS	-	-	✓
Padded Side	BED/HF/PS	✓	✓	✓

Mattress Type	Code	RAIL/W/COLOUR	RAIL/W/HE/EX/ COLOUR
Foam Mattresses			
<i>Standard Range</i>			
Softrest VE	MAT/SOFT/VE	✓	✓
Softrest	MAT/SOFT	✓	✓
Softrest Contour	MAT/SOFT/CON	✓	✓
Permaflex ST	MAT/SOFT/PERM	✓	✓
MAT 10	MAT10BE	-	✓
MAT 20	MAT20BE	✓	✓
MAT 30	MAT30HS	✓	✓
<i>Premium Range</i>			
Permaflex Plus	MAT/ACCL/PERM/PLUS	✓	✓
Permaflex HSF	MAT/ACCL/PERM/HSF	✓	✓
Acclaim VE	MAT/ACCL/VE	✓	✓
Memaflex	MAT/ACCL/MF	✓	✓
Foam Mattress Extensions			
Softrest	MAT/SOFT/EX	✓	✓
Softrest (with straps)	MAT/SOFT/EX/STRAPS	✓	✓
Acclaim VE	MAT/ACCL/VE/EX/STRAPS	✓	✓
Dynamic Pumps and Mattresses			
Eros Dial Pump	EROS/PUMP	✓*	✓
Theia Digital Pump	THEIA/PUMP	✓*	✓
Drive Dynamic Overlay	OVERLAY/MAT	✓*	✓
Drive Air on Foam	FULL/MAT	✓*	✓
Dynamic Systems			
Simple Air	1001270001	✓*	✓
Atlas	DYN/DIG/ATLAS	✓*	✓
Apollo	DYN/DIG/APOLLO	✓*	✓
Artemis	DYN/DIG/ARTEMIS	✓*	✓
Athena	DYN/DIG/ATHENA	✓*	✓
Rails and Pads			
Standard Grab Handle	1210/GRAB	✓**	-
Short Grab Handle	1216/GRAB	-	-
Padded Side	WOOD/SR/PS	✓*	✓
Padded Side	WOOD/SR/HEX/PS	-	✓
Padded Side	BED/HF/PS	✓	✓



Caution

- It is essential that dynamic mattress straps are only attached to the moving parts of the profiling mattress platform. If the straps are incorrectly fitted around the main section of the mattress platform, serious damage could occur to various components of the bed. If in doubt contact your provider or Drive DeVilbiss Healthcare Ltd.
- Ensure the dynamic control box is not positioned on the side rails, risk of control unit falling off when side rails are lowered.
- When fitting a mattress, ensure it is seated inside the mattress retainers at the sides and foot end of the bed.



Warning

- * If the dynamic mattresses listed are used without side rail height extensions a patient risk assessment must be performed to ensure the gap between the top of the mattress and top of the side rail when raised is acceptable and will not introduce a hazard to the patient.
- ** Care must be taken when raising/lowering the RAIL/W/COLOUR, RAIL/M/D/S or RAIL/M/ND/S and their extended versions when used in conjunction with the 1210/GRAB, as the gap between the two components can introduce a finger entrapment hazard, positioning dependent.
- When using the bed with a dynamic mattress, the space introduced by cell compression at the mattress edge and the side rail (if fitted) is to be considered. A patient risk assessment must be performed to ensure an asphyxiation risk is not introduced by the patients face inadvertently sinking into the gap between the mattress and side rail.
- Ensure extension blocks are positioned centrally to the platform. If offset to one side a gap will be introduced between the extension block and the side rail, introducing a potential asphyxiation risk.
- When the height extension is used in conjunction with a foam mattress ensure patient ingress/egress is not compromised - if so, remove and refit the height extension as required during patient transfers.
- Care must be taken when raising the backrest when used in conjunction with the 1210/GRAB, as the gap between the two components can introduce a finger entrapment hazard with the mattress retainers, positioning dependent. Refer to INSTRUC/1210/GRAB for specific positioning detail.
- The use of a dynamic mattress, when the bed is in an extended state, is dependent on the outcome of an individual risk assessment. When using a Drive DeVilbiss mattress that is equipped with static head cells, the risk assessment is to take into account that these static cells will have moved down the bed if the foot end of the mattress is positioned at the foot of the extended bed.

Drive DeVilbiss Healthcare Ltd. cannot be held responsible for any injury or incident which relates to the use of any product combinations not approved by Drive DeVilbiss Healthcare Ltd.

It is the carer's responsibility for selecting and fitting the products correctly and ensuring that the product combination is compatible.

19. SERVICE LIFE

The Casa Elite bed has a service life of 10 years* with the exception of:

- Battery pack: 1 year service life (CASA/BATTERY/1 only).

The accessories listed in section 18 have a service life of 10 years* with the exception of:

- Side rail pads: 1 year service life
- Mattresses: Refer to the individual instructions for use

*On the basis that the bed and its associated accessories are serviced and maintained in accordance with the information detailed in section 14 of these instructions for use and the individual instructions provided with the accessory in question.

20. WARRANTY

Drive DeVilbiss Healthcare Ltd. warrants that this product will perform in accordance with its specification and will remain free from defects in material and workmanship when used under normal conditions for a period of 2 years (which specifically is - 1 year full parts and labour, 1 further year parts only) from the date of purchase from Drive DeVilbiss Healthcare Ltd. and its subsidiary companies. If purchased from an authorised dealer or international distributor, the product is warranted for 1 year parts only. If a Drive DeVilbiss Healthcare Ltd. service contract is taken on the bed from year 1 (i.e. from the first service after 12 months from the date of purchase), a full parts and labour warranty is provided on the bed for the period in which the service contract is maintained, up to a maximum of 10 years from the date of purchase.

DRIVE DEVILBISS HEALTHCARE LTD. MAKES NO OTHER WARRANTIES, EXPRESS OR IMPLIED, AND ALL IMPLIED WARRANTIES OF MERCHANTABILITY, NON-INFRINGEMENT AND FITNESS FOR A PARTICULAR PURPOSE ARE HEREBY DISCLAIMED. IN NO EVENT WILL DRIVE DEVILBISS HEALTHCARE LTD. BE LIABLE FOR PUNITIVE, SPECIAL OR CONSEQUENTIAL DAMAGES, OR FOR AN AMOUNT IN EXCESS OF THE PURCHASE PRICE OF THE DEFECTIVE DRIVE DEVILBISS HEALTHCARE LTD. PRODUCT OR PRODUCTS.

Proof of purchase must be presented with any claim. Except as provided herein, this warranty will not apply to any Drive DeVilbiss Healthcare Ltd. products that have been (a) damaged by lightning, water, or power surges, (b) neglected, altered, abused, or used for a purpose other than the purpose for which they were designed, (c) repaired by you or any other party without Drive DeVilbiss Healthcare Ltd. prior written authorisation, (d) used in conjunction with a third party product or products not approved in advance by Drive DeVilbiss Healthcare Ltd., (e) damaged or failed by or attributes to acts of God, (f) damaged, caused by failure to follow instructions, or (g) otherwise used in a manner inconsistent with any instructions provided by Drive DeVilbiss Healthcare Ltd. The warranty explicitly exempts consumable items.

This warranty contains the entire agreement between you and Drive DeVilbiss Healthcare Ltd. with respect to any warranty matters, and supersedes any and all other written or oral statements, representations or agreements relating to the subject matter of this warranty.

In the event of a product defect during the warranty period you should contact your supplier, whether it be Drive DeVilbiss Healthcare Ltd., its subsidiary companies, authorised dealers or international distributors who will at their option unless otherwise provided by law; a) correct the defect by product repair within the terms of the warranty b) replace the product with one of the same or similar design or c) refund the purchase price. All replaced parts and products on which a refund is made become the property of Drive DeVilbiss Healthcare Ltd. Repaired or replaced parts and products are warranted for the remainder of the original warranty period. You will be charged for repair or replacement of the product made after the expiration of the warranty period.

This limited 2 year warranty gives you specific legal rights and you may also have other rights.

Drive DeVilbiss Healthcare Ltd. cannot be held responsible for any injury or incident which relates to the use of this bed in conjunction with accessories manufactured by companies other than Drive DeVilbiss Healthcare Ltd.

Drive DeVilbiss Healthcare Ltd. has a policy of continual product improvement and reserves the right to amend specifications covered in this document. No part of this document may be reproduced without the written approval of Drive DeVilbiss Healthcare Ltd.

Side Rail Community Design Registration Number: 002742254



CONTACT INFORMATION

Tel: +44 (0) 845 0600 333 Fax: +44 (0) 845 0600 334

Email: info@drivedevilbiss.co.uk

www.drivedevilbiss.co.uk



Drive DeVilbiss Healthcare Ltd., Holmfield, Halifax,
West Yorkshire, HX2 9TN, United Kingdom

A member of the Drive DeVilbiss Group of Companies



ORIGINAL INSTRUCTIONS
INSTRUC/CASA/ELITE, 2024/08 rev10