



Instructions for use

PARI LC PLUS®

PARI LC STAR®

PARI LC PLUS® Baby

Model: PARI LC PLUS (Type 022)

Nebulisers for PARI inhalation systems

Important: Read these instructions carefully before using the product for the first time. Follow all instructions and safety instructions!

Keep the instructions in a safe place.

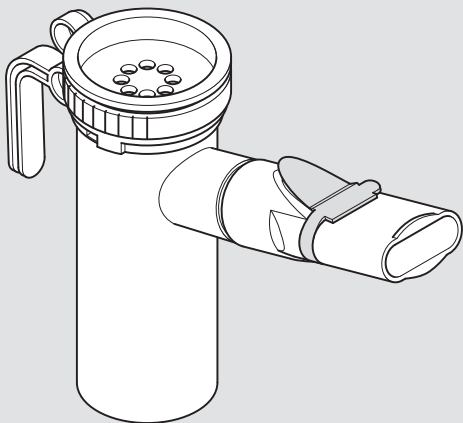

Identification, validity, version

These instructions for use are valid for PARI nebulisers (Type 022) in the following countries:

Countries outside the EU

Version of these instructions for use: Version F – 2020-02,

Approved version dated 2019-11-15

Information as of: 2019-11

The current version of the instructions for use can be downloaded from the internet as a PDF file:

www.pari.com (on the respective product page)

Formats available for visually impaired patients

The instructions for use available in PDF format on the internet can be enlarged for printing.

CE conformity

This product satisfies the requirements of 93/42/EEC (Medical devices).

Trade marks

The following trade marks are registered trade marks of PARI GmbH Spezialisten für effektive Inhalation in Germany and/or other countries:

LC SPRINT®, LC PLUS®, PARI®

Copyright

©2020 PARI GmbH Spezialisten für effektive Inhalation
Moosstraße 3, 82319 Starnberg, Germany

No part of this documentation may be reproduced or processed, duplicated, translated or disseminated by electronic means without the prior, written consent of PARI GmbH.

All rights reserved. Technical and design changes and printing errors reserved. Principle shown in illustrations.

Legal manufacturer

PARI GmbH Spezialisten für effektive Inhalation
Moosstraße 3, 82319 Starnberg, Germany

Contact

For all product information and in the event of defects or questions about usage, please contact our Service Center:

Tel.: +49 (0)8151-279 220 (international)

+49 (0)8151-279 279 (German-speaking)

E-Mail: info@pari.de

TABLE OF CONTENTS

IMPORTANT INFORMATION	7
Intended purpose	7
Indication	8
Contraindications.....	8
Safety instructions	8
PRODUCT DESCRIPTION	11
Components	11
Product variants	12
Product combinations	12
Description of function	12
Material information	13
Operating life	13
USE	14
Preparing for treatment	14
Performing treatment.....	17
Ending the treatment	19
REPROCESSING	20
Preparation	20
Cleaning	20
Disinfecting	21
Care of the connection tube	22
Inspecting	22
Drying	22
Storage	23
TROUBLESHOOTING	23
TECHNICAL DATA	23
General nebuliser data	23
Aerosol data according to ISO 27427	24

MISCELLANEOUS	26
Disposal.....	26
Labelling	26
APPENDIX: Reprocessing in professional environments for use with several patients	27
Nebuliser	27
Connection tubing	29

1 IMPORTANT INFORMATION

1.1 Intended purpose

Aerosols¹ for inhalation are generated with the PARI LC PLUS, PARI LC STAR and PARI LC PLUS BABY nebulisers.

Together with a PARI compressor and PARI accessories, the nebuliser forms an inhalation system for treatment of the lower airways.

The nebuliser is suitable for use in treating patients in all age groups.

Only solutions and suspensions that are approved for use in nebuliser therapy may be used.

The nebuliser must only be used with a PARI compressor.

For reasons of hygiene, this PARI product must only be used in a home environment by a single patient.

The inhalation system must only be used by individuals who understand the contents of the instructions for use and are able to operate the inhalation system safely. Individuals in the following groups must be supervised by a person who is responsible for their safety:

- Babies, infants and children
- Individuals with limited capabilities (e.g., physical, mental, sensory)

If the patient is not able to operate the inhalation system safely himself, the therapy must be carried out by the responsible person.

An application takes between 5 and 10 minutes (depending on the quantity of fluid), but in no case more than 20 minutes.

The frequency and duration of use will be determined by the physician or therapist according to the individual needs of the patient.

1) Aerosol: Small particles of solid, liquid or mixed composition (fine "mist") suspended in gases or air.

1.2 Indication

For treatment of diseases of the lower airways.

1.3 Contraindications

This product is only designed for patients who are able to breathe by themselves and are conscious.

1.4 Safety instructions

The present instructions for use contain important information, safety instructions and precautionary measures.

The user must follow these in order to guarantee safe operation of this PARI product.

This PARI product must only be used as described in these instructions for use.

The instructions for use of the compressor and accessories used and the information for use of the inhalation solution used must also be followed.

General

Nebuliser aerosol characteristics differ from the information provided by the manufacturer if non-approved solutions or suspensions are used for nebulisation.

This product is not suitable for use in an anaesthetic breathing system or a ventilator breathing system.

Tracheotomised patients cannot inhale with a mouthpiece. For inhalation therapy, they require specific equipment. In this case, please contact your doctor for further information.

If your health condition is not improved, or even worsens as a result of the treatment, seek professional medical advice.²

2) Professional medical staff: Doctors, pharmacists and physiotherapists.

Hazard due to small parts which can be swallowed

The product contains small parts. Small parts can block the airways and lead to a choking hazard. Keep all components of the product out of the reach of babies and infants at all times.

Hygiene

Observe the following hygiene instructions:

- Do not use product components unless they have been thoroughly cleaned and dried. Contamination and residual moisture encourage the growth of bacteria, which increases the risk of infection.
- Before every use and cleaning, wash your hands thoroughly.
- It is essential to clean and dry all product components before the first application as well.
- Always use drinking water for cleaning and disinfecting.
- Dry all product components completely after each cleaning and disinfection.
- Do not keep the product components in a damp environment or together with damp objects.

Treatment of babies, infants, and anyone who requires assistance

For individuals who are not able to perform the therapy session without assistance or cannot appreciate the hazards, the risk of injury is greater (e.g., strangulation with the power cord or the connection tubing). Such individuals include for example babies, children and people with limited capabilities. For these individuals, a person responsible for safety must supervise or carry out the application.

Identifying and classifying warning instructions

Safety-critical warnings are categorised according to the following hazard levels in these instructions for use:

DANGER

DANGER indicates a hazardous situation which will lead to severe injuries or death if it is not avoided.

WARNING

WARNING indicates a hazardous situation which can lead to severe injuries or death if it is not avoided.

CAUTION

CAUTION indicates a hazardous situation which can lead to mild or moderate injuries if it is not avoided.

NOTE

NOTE indicates a situation which can lead to material damage if it is not avoided.

2 PRODUCT DESCRIPTION

2.1 Components

The following components are included in the package:

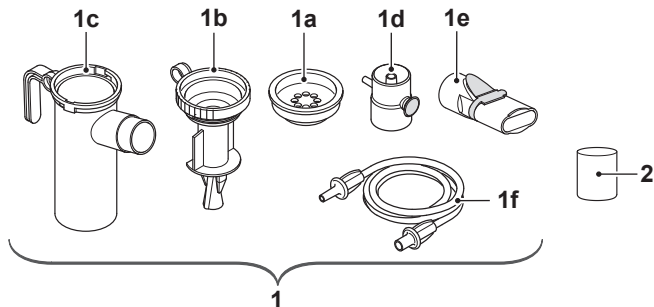

(1)	Nebuliser
(1a)	Inspiratory valve
(1b)	Nozzle insert
(1c)	Nebuliser lower part
(1d)	LC interrupter ³
(1e)	Mouthpiece ³
(1f)	Connection tubing ³
(2)	Air filter for compressor ³

³) Not included with all product variants.

2.2 Product variants

The PARI LC PLUS nebuliser is available in various versions for different age groups and requirements:

- PARI LC PLUS (nozzle insert: transparent)
With mouthpiece for treatment of the airways in adults and children aged approx. 4 years and older.
- PARI LC STAR (nozzle insert: red)
With mouthpiece for treatment of the deep airways in adults and children aged 4 years and older.
- PARI LC PLUS BABY (nozzle insert: red)
With PARI BABY mask and PARI BABY bend for treatment of the airways in babies (including premature babies) and children (aged 0 - 4 years).

i *Not all products are available in all countries.*

2.3 Product combinations

The PARI nebuliser can be operated with all PARI compressors. It can be used in combination with a range of PARI accessories.

2.4 Description of function

The PARI nebuliser is part of a PARI inhalation system.

When compressed air is supplied, the nebuliser generates an aerosol from the liquid, for example the medication with which it is filled. This aerosol is breathed into the lungs through the mouthpiece or optionally a mask.

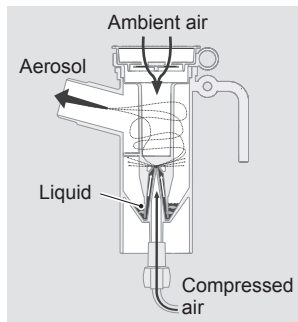

The LC interrupter makes it possible to interrupt aerosol generation while the patient breathes out, thereby optimising medication use.

2.5 Material information

The individual product components are made from the following materials:

Product component	Material
Inspiratory valve	Polypropylene, silicone
Nozzle insert	Polypropylene
Nebuliser lower part	Polypropylene
LC interrupter	Polypropylene
Mouthpiece (with exhalation valve)	Polypropylene, thermoplastic elastomer
Connection tubing	Polyvinyl chloride
Tubing endpiece	Thermoplastic elastomer

2.6 Operating life

The individual product components have the following expected operating lives:

Product component	Operating life
Nebuliser (all components except the connection tubing)	300 disinfections, max. 1 year
Connection tubing	max. 1 year

3 USE

People who assist others in carrying out the therapy must ensure that all of the steps described below are carried out correctly.

If the nebuliser is to be operated via a PARI CENTRAL on a central medical gas supply, the instructions for use of the PARI CENTRAL must be followed.

3.1 Preparing for treatment

Assembling the nebuliser

CAUTION

Risk of impaired treatment

Damaged components and/or an incorrectly assembled nebuliser may impair functioning of the nebuliser and thus treatment as well.

- Check all nebuliser components and the accessories before each use.
- Replace any broken, misshapen or seriously discoloured parts.
- Follow the assembly instructions in these instructions for use.
- Insert the nozzle insert in the nebuliser lower section.
- Gently twist the nozzle insert clockwise to lock it in place.

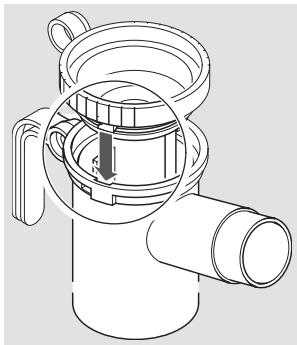

- Attach the connection tubing to the nebuliser.

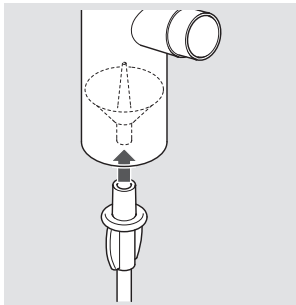

Or:

- Attach the LC interrupter to the nebuliser.
- Insert the connection tubing in the air inlet on the side of the LC interrupter.

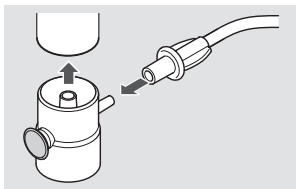

Using the mouthpiece

- Fit the mouthpiece onto the nebuliser.

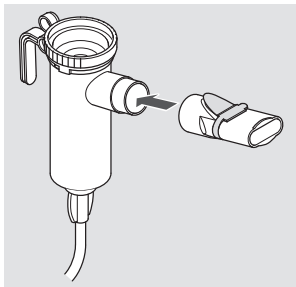

Using accessories

Information on assembling accessories is included in the instructions for use of the respective accessory.⁴

4) Instructions for use of accessories are included with the respective accessory. They can also be ordered from the manufacturer or dealer.

Filling the nebuliser

- Insert the nebuliser in the holder on the compressor intended for this purpose.
- If applicable, detach the inspiratory valve from the nebuliser.

- Pour the required quantity of inhalation solution into the top of the nebuliser.

Note the minimum and maximum fill volumes [see: General nebuliser data, page 23]. If the nebuliser contains too little or too much liquid, the nebulisation and consequently the therapy will be less effective.

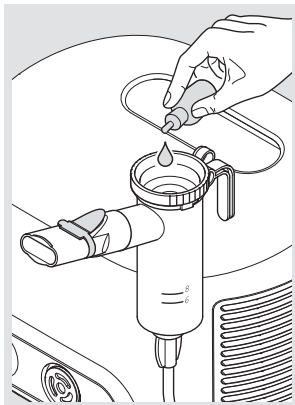

- Fit the inspiratory valve onto the nebuliser.

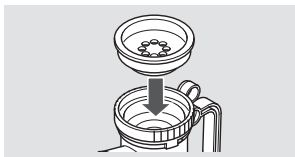

If several inhalation solutions are to be used one after the other:

- Rinse the nebuliser out with drinking water between the individual applications.
- Shake excess water out of the nebuliser.
- Fill the nebuliser with the next inhalation solution as described.

3.2 Performing treatment

All of the safety instructions in these instructions for use must have been read and understood before any treatment is carried out.

i Always hold the nebuliser upright during treatment.

Proceed as follows in order to carry out the treatment:

- Insert the connection tubing of the nebuliser with a slight twist into the air connection on the compressor.

⚠ DANGER! Life-threatening situation caused by mixing up tubes!

If tubing systems for other devices are present close by (e.g., for infusions), check carefully to ensure that the other end of the connection tubing connected to the compressor is connected to the nebuliser. Otherwise, there is a danger that different possible connections may be confused with each other.

- Take the nebuliser out of its holder and hold it upright.
- Verify that all parts are firmly connected to each other.

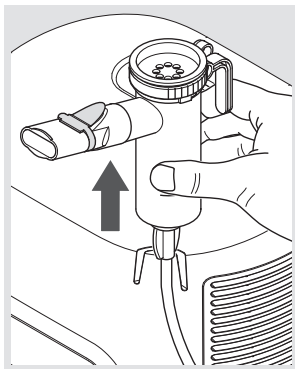
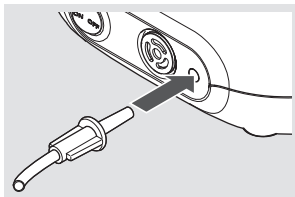

- Switch the compressor on.
⚠ DANGER! Danger of death by electrocution in the case of device fault! Switch the compressor off and disconnect the power plug from the mains socket immediately if a fault is suspected (e.g., following a fall or if there is a smell of burning plastic). If there is a fault in the device, it may be possible to come into contact with live parts. This in turn may lead to an electric shock.

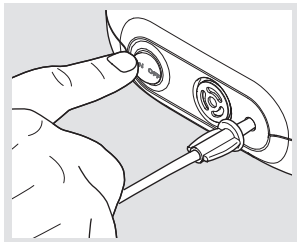

- Check that an aerosol is being generated before you begin the treatment.

Inhaling with the mouthpiece

- Sit in an upright position and relax.
- Hold the mouthpiece between your teeth and enclose it with your lips.
- Breathe in as slowly and deeply as possible through the mouthpiece, and out again calmly.
- Carry out the inhalation treatment until the noise in the nebuliser changes.

i *Some residual fluid will remain in the nebuliser after the end of the treatment.*

Using the LC interrupter

If the LC interrupter is attached, aerosol is not generated until the interrupter button is pressed. Proceed as follows to inhale and to interrupt aerosol generation when breathing out:

- Press the interrupter button to generate aerosol.

Info: *If the button cannot be pressed, it is locked and the LC interrupter has been set for permanent nebulising. In this case, unlock the interrupter button by turning it counter-clockwise as far as it will go.*

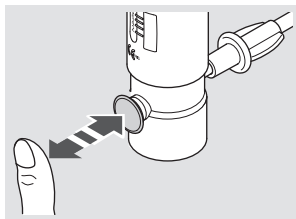

- Release the button to interrupt aerosol generation.

If you want to use the permanent nebulising function even with the LC interrupter fitted:

- Turn the interrupter button clockwise as far as it will go.
- ➔ The aerosol is generated permanently (**permanent nebulising**).

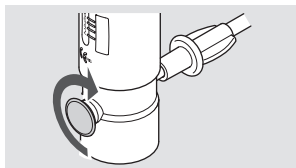

Inhaling with accessories

Inhalation with accessories (e.g., masks) is described in the instructions for use of the respective accessory.

3.3 Ending the treatment

To end the treatment, proceed as follows:

- Switch the compressor off.
- Place the nebuliser back in the holder on the compressor.
- Disconnect the power plug from the mains socket.

i *Complete disconnection from the mains is only certain when the power plug has been unplugged from the socket.*

4 REPROCESSING

The product components must be cleaned thoroughly immediately after each use and disinfected at least once a day.

If the nebuliser is used in **professional environments**, follow the information on reprocessing included in the appendix at the end of these instructions for use.

4.1 Preparation

- Detach the tube from the nebuliser.
- Detach the mouthpiece from the nebuliser.
- Make sure that all residual volume is removed from the nebuliser.
- Dismantle the nebuliser into its individual parts.
- Carefully pull the blue exhalation valve out of the slot in the mouthpiece. The exhalation valve must still be attached to the mouthpiece.

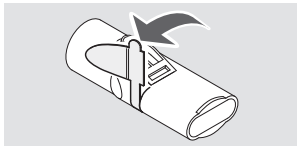

4.2 Cleaning

i *The connection tube cannot be cleaned or disinfected. Regarding care of the connection tube, follow the instructions in the corresponding section [see: Care of the connection tube, page 22].*

- Briefly rinse all parts used in running drinking water beforehand.
- Place all disassembled components in warm drinking water with a little dishwashing liquid for about 5 min.

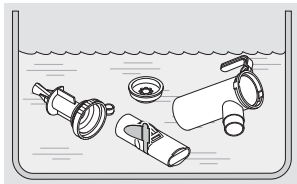

- Rinse off all parts thoroughly in drinking water.
- Shake the water out of all of the parts.

4.3 Disinfecting

After cleaning, disinfect all of the **disassembled parts** (only parts that have been cleaned can be disinfected effectively). The recommended disinfection procedures are described below. Descriptions of other validated disinfection procedures are available from the manufacturer or dealer upon request.

i *The connection tube cannot be cleaned or disinfected. Regarding care of the connection tube, follow the instructions in the corresponding section [see: Care of the connection tube, page 22].*

CAUTION

Risk of infection due to moisture

Moisture encourages the growth of bacteria.

- Remove all parts from the pot or disinfectant as soon as the disinfection process is finished.
- Dry all parts.

In boiling water

- Place all the **individual parts** in boiling water for at least 5 minutes. Use a clean pot and drinking water.

NOTE! Risk of damage to plastic parts! Plastic will melt if it comes into contact with the hot base of the pot. Make sure there is enough water in the pot to prevent the individual parts from touching the pot base.

- Shake the water out of all of the parts.

Using a standard thermal disinfecter for baby bottles (not a microwave oven)

CAUTION

Risk of infection due to inadequate disinfection

Inadequate disinfection encourages the growth of bacteria and thus increases the risk of infection.

- Make sure that the disinfecter is clean and operating properly before every disinfection process.
- Allow the disinfection to continue until the disinfecter switches off automatically or the minimum disinfection time stated in the instructions for use of the disinfecter has elapsed. Do not switch the device off prematurely.

Use a thermal disinfecter with a runtime of at least 6 minutes. Regarding the performance of the disinfection, the duration of the disinfection procedure and the quantity of water required, follow the instructions for use of the disinfecter you are using.

4.4 Care of the connection tube

Dry the connection tube after every inhalation session:

- Connect the connection tube to the compressor.
- Switch your compressor on.
- Leave the compressor to work until the air flowing through the tube has removed all traces of any condensation in the tube.

4.5 Inspecting

Inspect all product components after each cleaning and disinfection. Replace any broken, misshapen or seriously discoloured parts.

4.6 Drying

After each cleaning and disinfection, place all product components on a dry, clean and absorbent surface and let them dry completely.

4.7 Storage

Store this product as described below:

- Wrap all individual components in a clean, lint-free cloth (e.g., a tea towel).
- Store this product in a dry, dust-free place.

5 TROUBLESHOOTING

Fault	Possible cause	Remedy
No aerosol is coming out of the nebuliser.	The nebuliser nozzle insert is blocked.	Clean the nebuliser.
	The connection tubing is not connected properly.	Check that the tubing connectors are connected firmly to the compressor and the nebuliser.
	The connection tubing is leaking.	Replace the connection tubing.

6 TECHNICAL DATA

6.1 General nebuliser data

Size ⁵	10 cm × 9.5 cm × 4.5 cm
Weight ⁵	27.5 g to 29.5 g
Operating gases	Air
Minimum compressor flow	3.0 l/min.
Minimum operating pressure	0.5 bar / 50 kPa
Maximum compressor flow	6.0 l/min.
Maximum operating pressure	2.0 bar / 200 kPa
Minimum fill volume	2 ml
Maximum fill volume	8 ml; PARI LC STAR: 6 ml

5) Without mouthpiece; unfilled.

6.2 Aerosol data according to ISO 27427

The aerosol characteristics presented in these instructions for use were determined in accordance with ISO 27427 using Salbutamol. If other solutions or suspensions are used for nebulisation, the aerosol characteristics may differ from the values shown (particularly if they have greater viscosity).

The following data is based on tests according to a standard which takes adult breathing patterns as a basis. Therefore, these figures will probably differ from corresponding figures that were calculated for populations of children and infants.

Nozzle insert (red)	Minimum compressor flow (3 l/min – 0.6 bar)	Nominal compressor flow (4 l/min – 1.2 bar) ⁶	Maximum compressor flow (6 l/min – 1.9 bar)
MMAD [μm] ⁷	3.3	2.7	2.0
GSD ⁸	2.03	2.17	2.23
Respirable fraction [% < 5 μm]	71.8	79.2	86.3
Aerosol fraction [% < 2 μm]	23.6	35.0	49.4
Aerosol fraction [% > 2 μm < 5 μm]	48.2	44.2	36.9
Aerosol fraction [% > 5 μm]	28.2	20.8	13.7
Aerosol output [ml]	0.44	0.49	0.34
Aerosol output rate [ml/min]	0.05	0.07	0.08
Residual volume [ml] (gravimetric)	0.99	0.94	0.99

6) Operation with PARI COMPACT2 compressor (Type 152).

7) MMAD = Mass Median Aerodynamic Diameter

8) GSD = Geometric Standard Deviation

Nozzle insert (red)	Minimum compressor flow (3 l/min – 0.6 bar)	Nominal compressor flow (4 l/min – 1.2 bar)⁶	Maximum compressor flow (6 l/min – 1.9 bar)
Percentage of fill volume emitted per minute [%/min]	2.4	3.5	4.1

Nozzle insert (transparent)	Minimum compressor flow (3 l/min – 0.6 bar)	Nominal compressor flow (4 l/min – 1.2 bar)⁶	Maximum compressor flow (6 l/min – 1.9 bar)
MMAD [μm] ⁷	5.4	4.5	3.4
GSD ⁸	2.13	2.23	2.31
Respirable fraction [% < 5 μm]	44.0	53.2	66.2
Aerosol fraction [% < 2 μm]	11.6	17.9	28.1
Aerosol fraction [% > 2 μm < 5 μm]	32.4	35.3	38.1
Aerosol fraction [% > 5 μm]	56.0	46.8	33.8
Aerosol output [ml]	0.30	0.40	0.38
Aerosol output rate [ml/min]	0.09	0.12	0.14
Residual volume [ml] (gravimetric)	1.28	1.15	1.14
Percentage of fill volume emitted per minute [%/min]	4.4	5.9	6.9





7 MISCELLANEOUS

7.1 Disposal

All product components can be disposed of with domestic waste unless this is prohibited by the disposal regulations prevailing in the respective member countries.

7.2 Labelling

The following symbols can be found on the product and/or the packaging:

	Legal manufacturer
	The product satisfies the basic requirements as set forth in Appendix I of Directive 93/42/EEC concerning medical devices.
	Consult instructions for use
	Item number
	Production batch number, lot

APPENDIX: Reprocessing in professional environments for use with several patients

Nebuliser

The following overview of the processing steps in professional environments applies to the following products:

- Nebuliser
- LC interrupter

1. Preparation

Disassemble the product [see: Preparation, page 20].

Check:

- Expiry date of the cleaning agent/disinfectant
- Processing limits reached?

2. Cleaning and disinfection

Manual cleaning:	pH-neutral, enzymatic cleaner, e.g., Korsolex® Endo Cleaner (Bode) or Bodedex® forte (Bode) Use: In accordance with manufacturer information, if dirt is visible use a brush if necessary.
Manual disinfection:	<p>With aldehyde-containing instrument disinfectant, e.g., Korsolex® Basic (Bode) Use: In accordance with manufacturer information Active agent basis: – Aldehyde donor ¹ – Aldehyde ¹</p> <p>With aldehyde-free instrument disinfectant Use: In accordance with manufacturer information Active agent basis: Quaternary ammonium compound <i>Info: Bomix® plus cleans and disinfects in a single work step</i></p>
Mechanical cleaning with disinfection:	Neutral cleaning agent, e.g., neodisher® Medizym (Dr. Weigert) or alkaline cleaning agent, e.g., neodisher® MediClean forte 0.5% (Dr. Weigert) in conjunction with neutraliser, e.g., neodisher® Z (Dr. Weigert) Equipment: Cleaning device and disinfectant in conformance with DIN EN ISO 15883, e.g., RDG G7836 CD (Miele) Vario TD programme or comparable valid programmes

1) Additional activity spectra: tuberculocidal, mycobactericidal, fungicidal
According to the information supplied by the disinfectant manufacturers, the agents listed are effective against the gram-positive bacteria *Staphylococcus aureus* and *Enterococcus hirae* and against the gram-negative bacteria *Escherichia coli*, *Pseudomonas aeruginosa* and *Proteus mirabilis* as well as the yeast-like fungus *Candida albicans*.

3. Steam sterilisation

Equipment:

- Steam steriliser (preferably with fractionated pre-vacuum) in accordance with DIN EN 285 or DIN EN 13060 (Type B)
- Sterile barrier system in accordance with DIN EN 11607

Temperature / Duration:

134 °C for at least 3 min.

4. Visual inspection & storage

Check:

Inspect all individual parts. Replace any broken, misshapen or seriously discoloured parts.

Storage location:

- dry
- dust-free
- protected from sources of contamination
optional: Use sterile packaging

Processing limits

max. 300 disinfection cycles, max. 1 year

Connection tubing

1. Preparation

Check the product:

- Expiry date of the cleaning agent/disinfectant
- Processing limits reached?

2. Cleaning and disinfection

Manual cleaning:	not applicable
Manual disinfection:	not applicable

<p>Mechanical cleaning with disinfection:</p>	<p>Alkaline cleaning agent, e.g., neodisher® MediClean forte (Dr. Weigert) in conjunction with neutralising agent, e.g., neodisher® Z (Dr. Weigert)</p> <p>Equipment:</p> <ul style="list-style-type: none">– Cleaning device and disinfector in conformance with DIN EN ISO 15883, e.g., RDG G7836 CD (Miele)– Special baskets for Miele instrument dishwasher– Compressed air source for blowing dry <p>Vario TD programme or comparable valid programmes</p>
---	---

3. Steam sterilisation

not usable

4. Visual inspection & storage

Inspect all individual parts. Replace any broken, misshapen or seriously discoloured parts.

Storage location:

- dry
 - dust-free
 - protected from sources of contamination
- optional: Use sterile packaging

Processing limits

max. 50 processing cycles



PARI GmbH

Spezialisten für effektive Inhalation

Moosstraße 3

82319 Starnberg • GERMANY

info@pari.de • www.pari.com

